

SAX Electronic Valve Actuator

Non-spring Return, 24 Vac, Proportional Control



Description

The SAX Non-spring Return (NSR), Electronic Valve Actuator requires a 24 Vac supply and receives a 0 to 10 Vdc or a 4 to 20 mA control signal to proportionally control a valve. This actuator is designed to work with Flowrite 599 Series 2-way and 3-way valves or Siemens flanged, Pressure Independent Control Valves with a 3/4-inch (20 mm) stroke.

Features

- 24Vac/Vdc operating voltage
- Direct-coupled installation requires no special tools or adjustments
- Visual and electronic stroke indication
- Manual override
- Automatic stroke calibration
- LED status indication
- Overload and stall protection.
- Optional functions with auxiliary switches, function module, and stem heater
- Maintenance-free

Application

These electronic actuators are designed to be used with Flowrite 599 Series valves with 3/4-inch (20 mm) stroke in hot and chilled water, and low pressure (<15 psi) steam service applications, or with Siemens flanged, Pressure Independent Control valves with 3/4-inch (20 mm) stroke in hot and chilled water applications in closed loop HVAC systems.

Product Number

SAX61.03U (Actuator Prefix Code 371)

Specifications	Operating voltage	24 Vac \pm 20% / 24 Vdc + 20% / -15%, Class 2
	Power supply	Frequency Fusing of supply lines
	Power consumption Stem retracts/extends	45 to 65 Hz Max. 10A slow 8 VA/3.75 W
Function data	Positioning times	30 s
	Positioning force	800 N
	Nominal stroke	20 mm
	Permissible medium temperature (valve fitted)	-13°F to 266°F (-25°C to 130°C)
Signal inputs	Positioning signal "Y" (0 to 10 Vdc) Current draw	\leq 0.1 mA
	Input impedance	\geq 100K Ω
	(4 to 20 mA) Current draw	DC 4 to 20 mA \pm 1%
	Input impedance	\leq 500 Ω
Parallel operation		\leq 10 (depending on controller output)
Forced control	Positioning signal "Z" SAX61.03U	R = 0 to 1,000 Ω , G, G0
	R = 0 to 1,000 Ω	Stroke proportional to R
	Z connected to G	Maximum stroke 100%
	Z connected to G0	Minimum stroke 0%
Voltage	Max. 24 Vac \pm 20%	
Current draw	Max. 24 Vdc + 20% / - 15%	
		\leq 0.1 mA
Position feedback	Position feedback U	0 to 10 Vdc \pm 1%
	Load impedance	> 10K Ω res.
	Load	Maximum 1mA
Connecting cable	Wire gauge	16 to 24 AWG
	Cable entries	3 entries for 1/2" conduit connection
Degree of protection	Housing from vertical to horizontal	IP54, as per EN 60529
	With Weathershield ASK39.1	NEMA 3R
	Insulation class (for 24 Vac/Vdc)	Class III, as per EN 60730
Environmental conditions	Operation	IEC 60721-3-3
	Climatic conditions	Class 3K5
	Mounting location	Indoors (weather-protected)
	Ambient temperature	23°F to 131°F (-5°C to 55°C)
	Humidity (non-condensing)	5 to 95% rh
	Transportation	IEC 60721-3-2
	Climatic conditions	Class 2K3
	Temperature	-13°F to 158°F (-25°C to 70°C)
	Humidity	< 95% rh
	Storage	IEC 60721-3-1
	Temperature	5°F to 131°F (-15°C to 55°C)
	Humidity	5 to 95% rh
Max. media temperature when mounted on a valve	266°F (130°C)	

**Specifications
 (Continued)**

ISO 14001 (environment)
 ISO 9001 (quality)
 SN36350 (environment-compatible products)
 RL 2002/95/EG (RoHS)

Environmental compatibility

Standards

CE conformity As per EMC directive Immunity Emissions	2004/108/EC EN 61000-6-2:[2005] Industrial EN 61000-6-3:[2007] Residential
Electrical safety	EN 60730-1
C-tick	N 474
UL conformity (24 Vac/Vdc)	UL 873
C-UL conformity (24 Vac/Vdc)	Certified to Canadian standard C22.2 No. 24-93

Accessories

Auxiliary switch ASC10.51 Switching capacity	24 to 230 Vac, 6A res., 2A Ind.
Stem heating element ASZ6.6	24 Vac, 40 VA/30W

Accessories

NOTE: Installation instructions are included with each accessory.

Product Number	Auxiliary Switch ASC10.51	Function Module AZX61.1	Stem Heating Element ASZ6.6
SAX61.03U	Max. 2	Max. 1	Max. 1

**Auxiliary switch
ASC10.51**

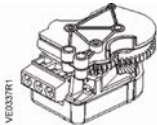

Auxiliary switch ASC10.51 switches on or off when a certain position is reached. The switching point can lie between 0 to 100%.

**Function module
AZX61.1**

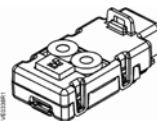

Function module AZX61.1 offers the following choices for changing control:

- Changeover of acting direction
- Sequence control (adjustable start and span)

**Stem Heating Element
ASZ6.6**

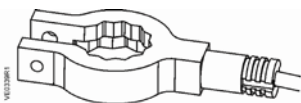

Stem heating element ASZ6.6 prevents the formation of ice on the stem when the medium temperature drops below 32°F (0°C). It is suited for universal use with valves having a stem or spindle diameter of 10 or 14 mm.

Accessories, continued

Weather Shield
 ASK39.1

Weather Shield ASK39.1 protects the actuator when installed outdoors. Provides NEMA 3R protection.



Components

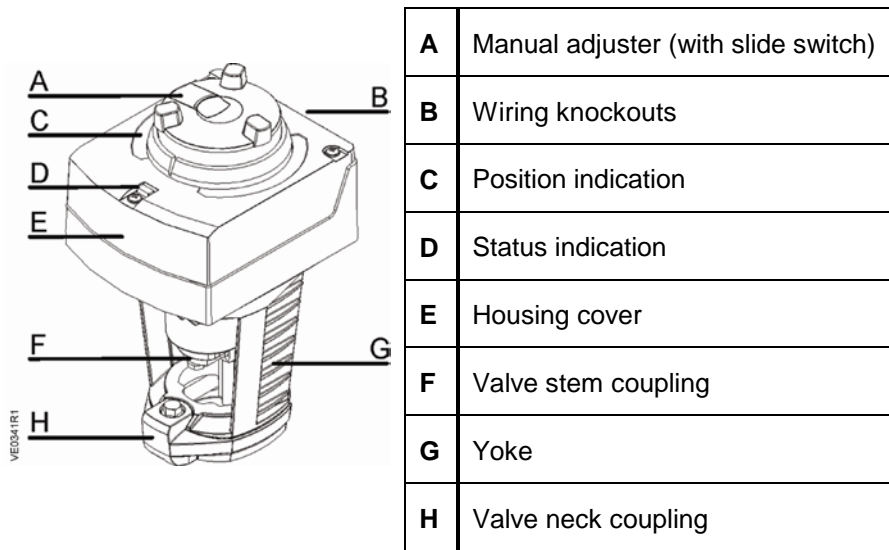

Operation

The actuator accepts a 0 to 10 Vdc or a 4 to 20 mA control signal and a microprocessor produces a stroke proportional to the input signal.

In the event of a power failure or with no control voltage, the damper actuator holds its position.

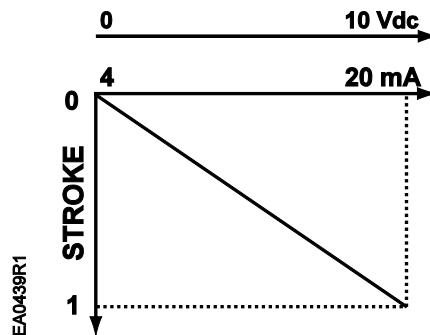

Stroke Calibration

To determine the stroke positions 0 and 100% in the valve, calibration is required when the valve/actuator are commissioned for the first time.

The actuator must be mechanically connected to a valve and must have a 24 Vac power supply. The calibration procedure can be repeated as often as necessary.



CAUTION:

Before starting calibration, be sure the manual adjuster is set to **Automatic** to register the actual values.

There is a slot on the printed circuit boards of the actuators. To initiate the calibration procedure, insert a flat-blade screwdriver into the calibration slot on the circuit board.

Calibration proceeds as follows: (See Figure 1).

1. Actuator runs to the 0% stroke position, and detects upper end position; green LED flashes.
2. Actuator then runs to the 100% stroke position, and detects lower end position; green LED flashes.
3. Measured values are stored in the EPROM. The actuator now moves to the position defined by control signal Y, and the green LED now glows steadily (normal operation).
 - Throughout this procedure, output U is inactive; meaning, the values only represent actual positions when the green LED stops flashing and remains on continuously.
 - Observe status indication LED during and after calibration. (See Table 1.)
 - If the actuator does not detect the second end position within an appropriate stroke range (25 mm), the first end stop will be adopted, and the actuator operates with a working range of 20 mm.

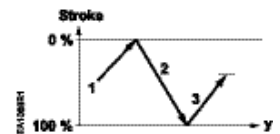

Figure 1.

Table 1. LED Status.

LED	Display	Function	Action
Green	ON	Automatic mode	Normal operation
	Flashing	Calibration In Progress	Wait until calibration is finished (then green or red light)
		In Manual mode	Manual adjuster in MAN position
Red	ON	Calibration error	Start calibration again
	Flashing	Detection of foreign object	Check the valve actuator
Off	OFF	No power or faulty electronics	Check operating voltage

Position Indication

The actuator position indicated by the position output signal "U" is calculated by a potentiometer that sends a feedback signal via the U terminal.

Manual Override

Automatic mode

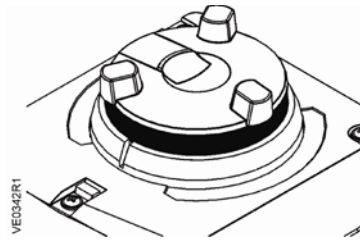

When the motor drives the manual adjuster turns. In Automatic Mode, the manual adjuster is used for indication of travel. If the manual adjuster is held firm in this mode, there is no transmission of power to the gear train.

Manual operation

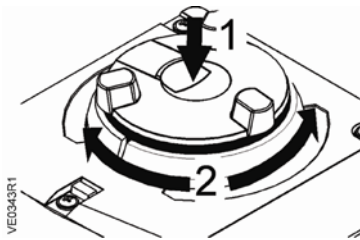

When pushing the manual adjuster down (1), it engages and the actuator can be manually operated.

When turning the manual adjuster in a clockwise/counterclockwise direction (2), the actuator's stem extends/retracts.

An overload protection prevents damage to the manual adjuster.

Setting the position

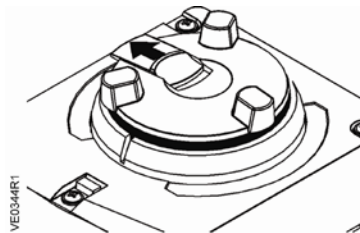

When the black slide switch is pushed out, the manual adjuster remains engaged.

When in this mode, do not turn the manual adjuster.

Disengaging the setting

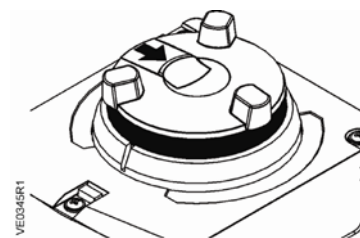

When the black slide switch is pushed back in, and the manual adjuster is not pressed down, the manual adjuster returns to Automatic Mode.

Automatic operation

The actuator will return to automatic operation when the manual adjuster is released.

Signal Priorities

The actuators are controlled via different interlinked positioning signal paths (positioning signal "Y", forced control input "Z", or manual override). The signal paths are assigned the following priorities (1 = highest priority, 3 = lowest priority):

Priority	Description	
1	The manual override always has priority 1, thus overriding all signals active at "Z" or "Y", independent of whether or not power is applied.	
2	As soon as a valid positioning signal is active at input "Z", the position is determined via positioning signal "Z" (forced control). Prerequisite: The manual override is not used.	Z
3	The position is determined via positioning signal "Y". The manual override is not used and on "Z" there is no active signal.	Y

Mounting and Installation

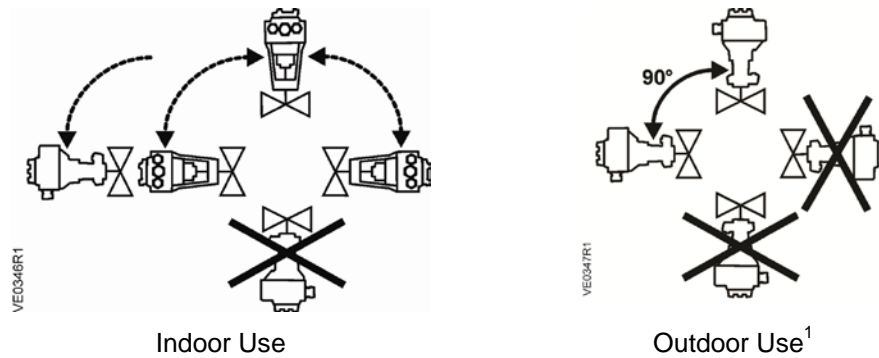

1) Only in connection with Weather Shield ASK39.1 for NEMA 3R protection.

Figure 2. Acceptable Mounting Positions.





The vertical position is the recommended position for mounting. Figure 2 shows the acceptable mounting positions.

Allow 8 inches (200 mm) above and on the wiring side of the actuator, and four inches (100 mm) on all other sides of the actuator. This service envelope is the minimum space required to access and service the actuator. See *Dimensions* for actuator dimensions and the recommended service envelope.

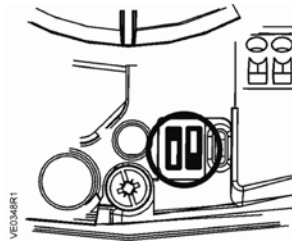
Positioning Signal and Flow Characteristic Selection

DIP switches



Position	Positioning Signal "Y"	Position Feedback "U"	Flow Characteristic
OFF ¹⁾	 0 to 10 Vdc	0 to 10 Vdc	 log = equal-percentage
ON	 DC 4 to 20 mA	0 to 10 Vdc	 lin = linear

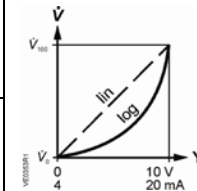

¹⁾ Factory setting: All DIP switches are set to OFF

Start-Up

Switch 1: Control Signal

Select between 0 to 10 Vdc or 4 to 20 mA input signal for terminal Y (0 to 10 Vdc default).

Switch 2: Flow Characteristic



CAUTION:

Do not change the characteristic switch. The proper flow characteristic is designed into the Flowrite 599 Series valve.

Changing the default setting will modify an equal percentage valve to a linear flow characteristic. When set to default, the flow characteristic is determined by the valve body.

NOTE: Set the actuator switches as specified. These switches do not reverse the action from NO to NC or vice versa. The valve body assembly determines the complete assembly action.

Check the wiring for proper connections.

Normally Closed Valve

Increasing the control signal extends the actuator (0 to 1): Valve opens.

Decreasing the control signal retracts the actuator (1 to 0): Valve closes.

Normally Open Valve

Increasing the control signal extends the actuator (0 to 1): Valve closes.

Decreasing the control signal retracts the actuator (1 to 0): Valve opens.

Three-Way Valve

Increasing the control signal extends the actuator (0 to 1): Valve opens between Ports A and AB (through port).

Decreasing the control signal retracts the actuator (1 to 0): Valve opens between Ports B and AB (bypass port).

Wiring

Do not use auto transformers. Use earth ground isolating step-down Class 2 power supplies.

Determine supply transformer rating by summing total VA of all actuators used.

The maximum rating for Class 2 step-down transformer is 100 VA. It is recommended that no more than 10 actuators are powered by one transformer.

Up to 10 actuators can be driven in parallel from a single controller output with a 1 mA rating. The SAX61.03U proportional actuator has an input impedance of 100K ohm.

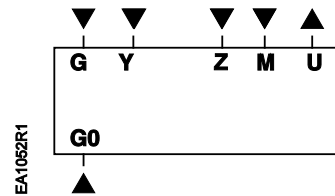
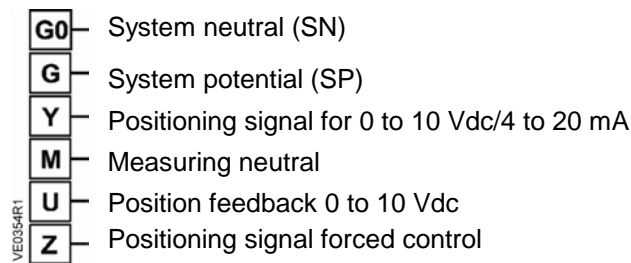

Figure 3. Connecting Terminals.

Wiring Terminals

24 Vac/Vdc, 0 to 10 Vdc, 4 to 20 mA, 0 to 1,000 Ω



Internal Diagrams

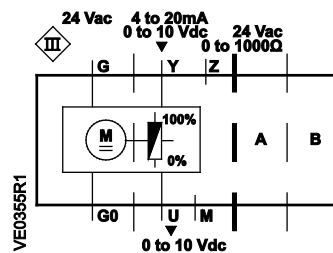

Accessories

A and/or B

1x ASC10.51
 Auxiliary Switch

24 Vac to 230V / 6 (3) A

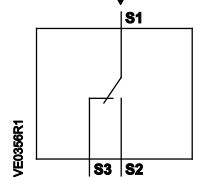

1x ASC10.51
 Auxiliary Switch

24 Vac to 230V / 6 (3) A

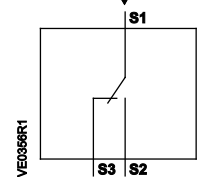

The diagram shows all possible connections. The application determines which connections are used.

Troubleshooting

- Check that the wires are connected correctly and attached securely.
- Check for adequate power supply.
- If the actuator moves erratically in very small steps, check that it is receiving adequate power.

Dimensions

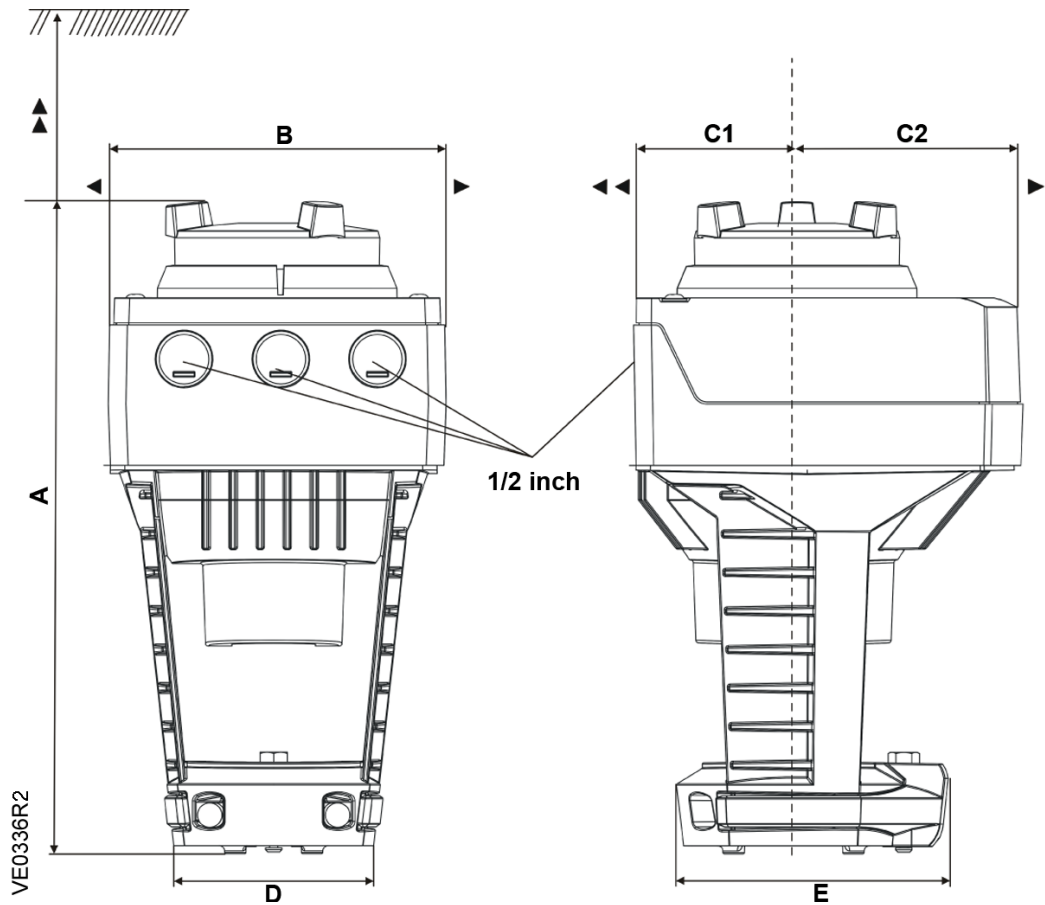
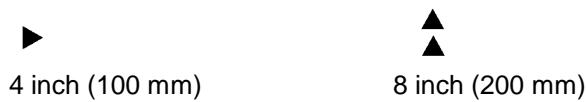

Figure 4. Dimensions in Inches (Millimeters).

Service envelope

Minimum access space recommended



Product Numbers	A	B	C	C1	C2	D	E	▶	▶▶	Weight lbs (kg)
SAX61.03U	9.53 (242)	4.88 (124)	5.91 (150)	2.68 (68)	3.23 (82)	3.15 (80)	3.94 (100)	3.94 (100)	7.87 (200)	4.1 (1.85)
With ASK39.1	10.51 (267)	6.06 (154)	11.81 (300)	7.87 (200)	3.94 (100)	–	–	–	–	4.6 (2.08)

Information in this publication is based on current specifications. The company reserves the right to make changes in specifications and models as design improvements are introduced. Product or company names mentioned herein may be the trademarks of their respective owners.

© 2014 Siemens Industry, Inc.