

Important: Retain these instructions

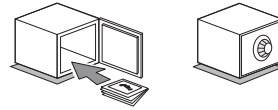

CONTENTS

1	Unpacking	1	3	Installation	1
2	Storing	1	4	Disposal	8

1 UNPACKING

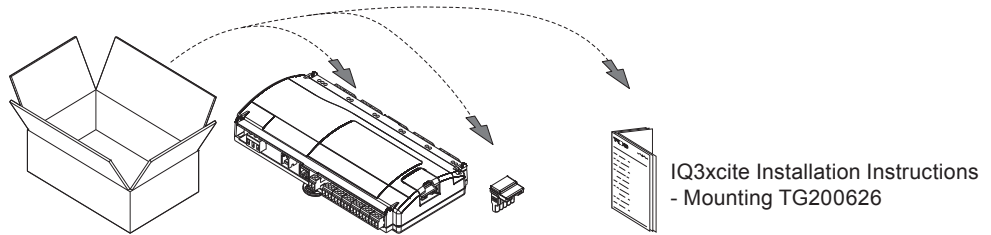

2 STORING

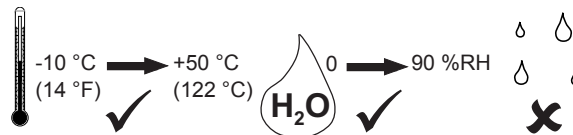

3 INSTALLATION

It is recommended that the installation should comply with the HSE Memorandum of Guidance on Electricity at Work Regulations 1989. For USA, install equipment in accordance with National Electric Code

WARNING: If the unit is used in a manner other than that specified in these instructions, the protection provided by the unit may be impaired.

DANGER: High voltage. No serviceable parts inside. Other than removing terminal cover, **DO NOT OPEN UNIT.**

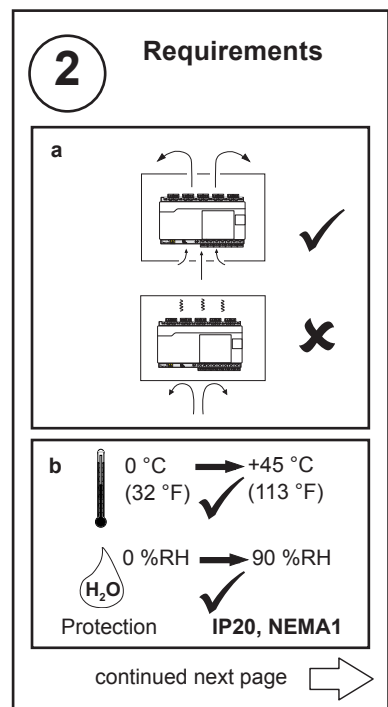
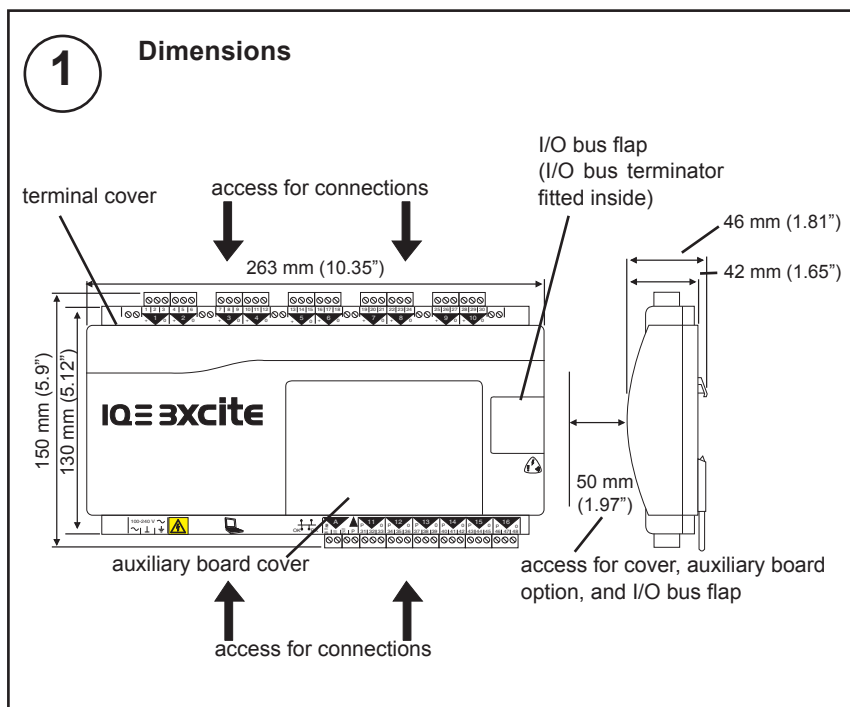

3 INSTALLATION (continued)

2 Requirements (continued)

c

IQ3XACT/12/USA/UL.../24 is UL rated as 'UL916 listed open energy management equipment'.

d

e

3 Mounting

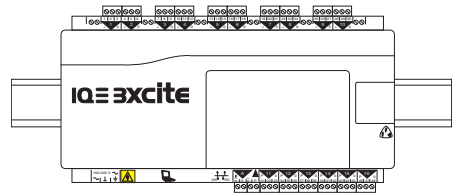
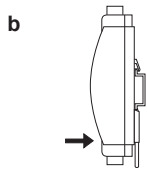
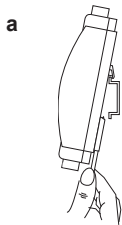

4 Connect Power

/100-240 100 to 240 Vac $\pm 10\%$ 50/60 Hz at 28 VA max (A 240 Vac, 1 A, switch or circuit breaker must be included in the supply to the unit and be in close proximity to it, and must be clearly marked as the disconnecting device for the unit.)

/24 24 to 60 Vdc (36 Vdc maximum for /UL versions), 24 Vac 50/60 Hz, at 40 VA max

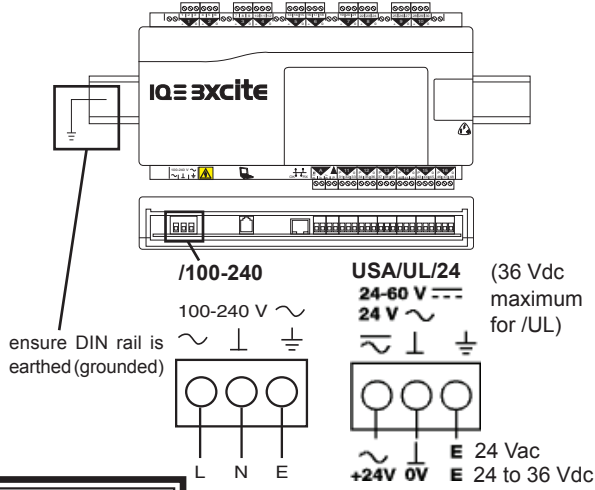

DO NOT APPLY POWER

Terminal size 0.5 to 2.5 mm² (14 to 20 AWG)
EN61010:2001
INSTALLATION CATEGORY III
(fixed installations)

WARNING:
This apparatus must be earthed (grounded) (through power connector)

5 Connect Ethernet

If required

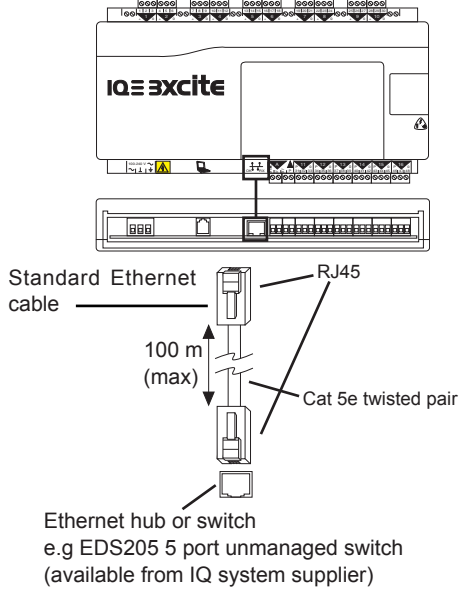

Note that a single device may be connected directly to the IQ3 from Ethernet using the standard Ethernet cable plus an XCITE/XA crossover adaptor, see 'Connect IPTool' (IQ3 Installation Instructions - Configuration TG201160, section 1 step 14)

Trend Ethernet Products
Engineering Guide
TE200369

3 INSTALLATION (continued)

6 Connect Inputs (channels 1 to 6) 

EN61010:2001 **MEASUREMENT CATEGORY 1**. Separate from 230 Vac input power supply by double or reinforced insulation. TP/1/1/22/HF/200 (Belden 8761) cable recommended for all inputs. Cable size 0.5 to 2.5 mm² (14 to 20 AWG) - Cu only.

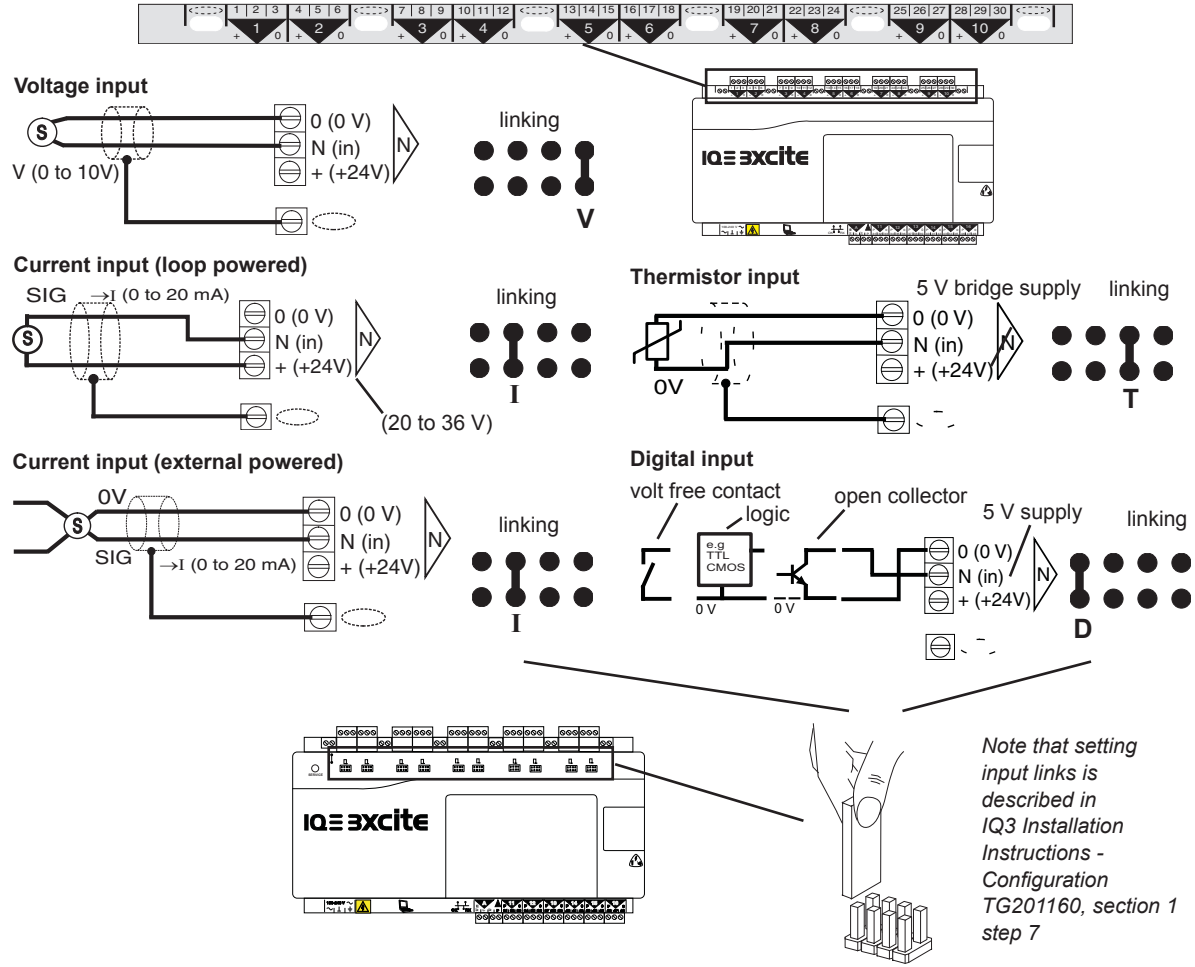

7 Segregate Screen Earth (Ground) 

if required to segregate screen earth (ground) from controller input power supply earth (ground)

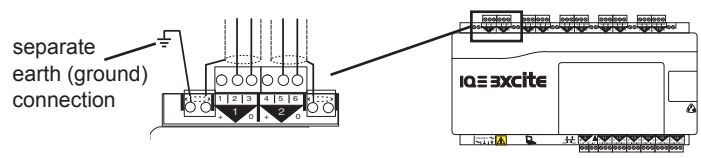

Note that screen earth (ground) link must be cut (see IQ3 Installation Instructions - Configuration TG201160, section 1 step 8)

3 INSTALLATION (continued)

8 Connect Outputs (channels 11 to 16)

EN61010:2001 **MEASUREMENT CATEGORY 1**. Separate from 230 Vac input power supply by double or reinforced insulation
 TP/1/1/22/HF/200 (Belden 8761) cable recommended for voltage outputs
 If screened cable is used, terminate screen to earth (ground) at one end

Cable size 0.5 to 2.5 mm² (14 to 20 AWG) - Cu only

WARNING
 If external supply is used to supply P input terminal, note whether P bus is 24 Vac or 24 Vdc and **only connect appropriate output devices to P output terminals**

If P terminal used, P input terminal must be connected as in step 9 below

Additional Relay Modules

- SRMV = x 1
- 2SRM = x 2
- 2RM = x 2 (R/L, H/L)
- 3RM = x 3 (HCM/TRM)
- 6RM = x 6

e.g.

~~SRMAC~~ Analogue outputs are not suitable for ac relays

9 Connect Output Power (P)
 if P terminal used (see step 8 above)

terminal size 0.5 to 2.5 mm² (14 to 20 AWG)

EN61010:2001 **MEASUREMENT CATEGORY 1**
 Separate from 230 Vac input power supply by double or reinforced insulation

Check IQ3 24 Vdc combined and auxiliary output current availability:
 IQ3 Configuration Manual TE200768

either use IQ3 24 Vdc auxiliary supply

Fit external link

or use 24 Vdc or 24 Vac external supply
 Connect external supply (no external link)

External PSU

WARNING
 External PSU must be dedicated to I/O channel use, and comply with relevant EMC and safety standards

WARNING
 If external supply is used, note whether P bus is 24 Vac or 24 Vdc and only connect appropriate output devices to P output terminals

10 Connect Auxiliary Supply (24 V $\overline{\text{---}}$) if required

Check IQ3 24 Vdc combined and auxiliary output current availability:
 IQ3 Data Sheet TA200505

terminal size 0.5 to 2.5 mm² (14 to 20 AWG)

EN61010:2001 **MEASUREMENT CATEGORY 1**
 Separate from 230 Vac input power supply by double or reinforced insulation

Note that the 24 Vdc supply is normally about 22 V and drops to about 20.7 V at full load.

IQ3
 0 V
 24 V $\overline{\text{---}}$

$I_{max} = 150 \text{ mA}$ (including current to P bus, - see step 9 above)

3 INSTALLATION (continued)

11 Auxiliary Board Installation
if auxiliary board already fitted

(for fitting and installing battery board, XCITE/BBC, see IQ3 Installation Instructions - Configuration TG201160, section 1 step 10). Note that fitting IQ3/LAN/UGR Lan board upgrade is described in IQ3/LAN/UGR installation instructions TG201162.

for IQ3../.../LAN/...

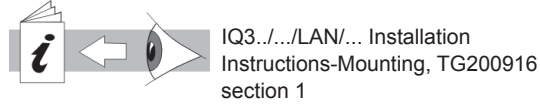

for IQ3../.../XNC/..., including IQ3../.../LAN/XNC/..., IQ3../.../SER/XNC/...

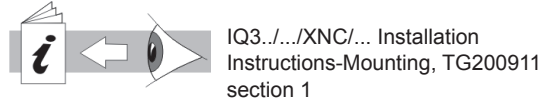

12 Install I/O Modules (IQ3XCITE/96/.. and /128.. only)
if required

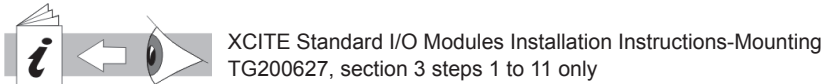

13 Connect I/O Bus (IQ3XCITE/96/.. and /128.. only)

a Open Flap

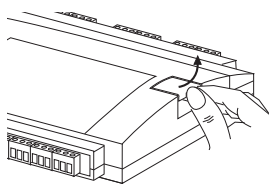

b Remove Terminator

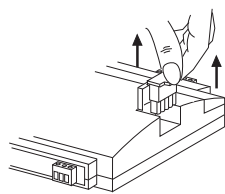

c either use XCITE/IC interconnector (supplied with I/O module)

XCITE/IC interconnector (supplied)
(XCITE/IC/5, pack of 5 available separately)

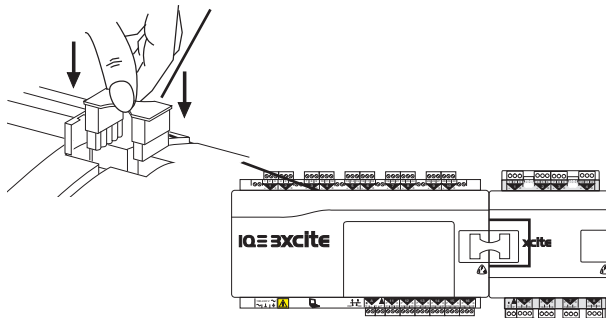

- A maximum of 15 I/O modules can be connected.
- A maximum of 96 or 128 points (16 points in the IQ3xcite and 80 or 112 expansion points) can be used.
- The controller and its I/O modules are to be fitted inside enclosures.
- No spurs are allowed on the I/O bus.
- If a single earth (ground) screened and bonded contiguous metal enclosure is used, then total I/O bus length can be up to 30 m (includes use of multisection panels e.g. Form 4 enclosures)
If any other type of enclosure is used, or I/O bus runs between enclosures, then total I/O bus cable length can be up to 10 m.
(For cable length calculation, rigid interconnectors can be ignored)
- Multiple enclosures must be earthed (grounded) to a common earth (ground) point (according to latest IEE Regs).

continued next page

3 INSTALLATION (continued)

13

Connect I/O Bus (continued)

c continued

or wire special cable using XCITE/CC connectors and Belden 3084A cable

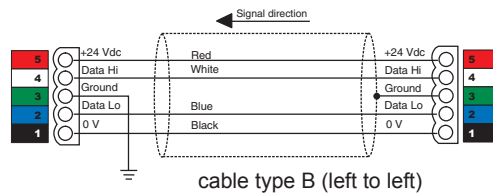
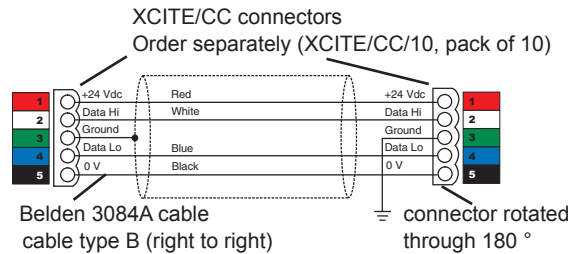
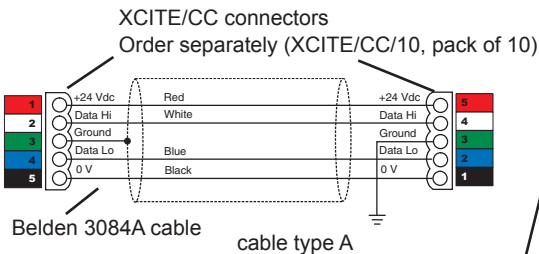
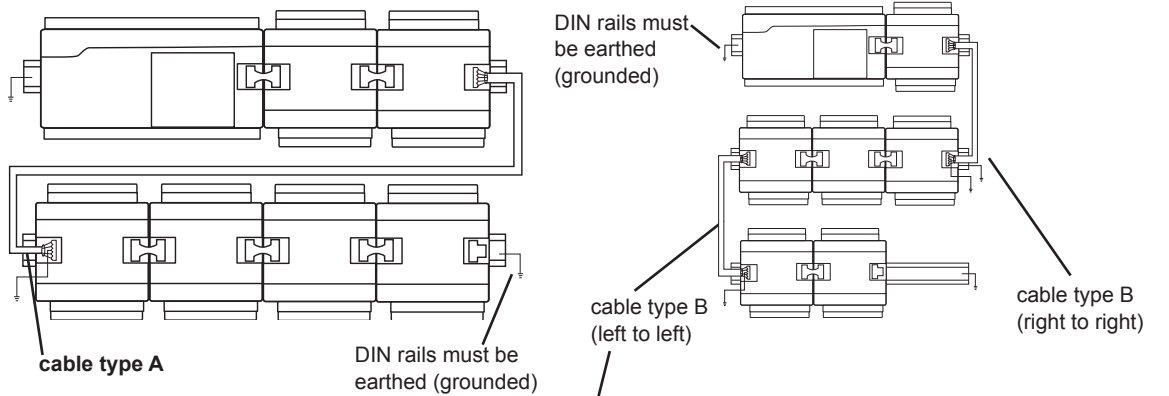

Fully screened and bonded contiguous multi-section cabinet

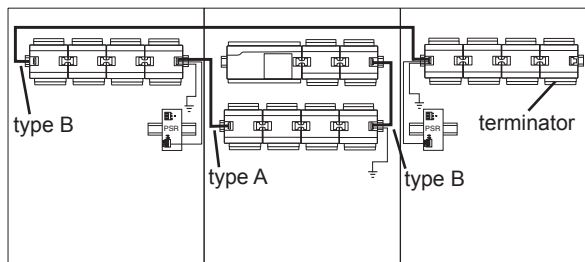

An additional 24 Vdc ±15% power supply must be used to supply the IO modules if:

- There are more than 6 I/O modules (excluding /8AO, /4AO, /16DI, /8DI, /8DI/8TI, /8DO/HOA, /4DO/HOA, and /8DO serial number >= M3D8 C0 508 1136, /4DO serial number >=M3D4 C0 508 012; which do not need to be included in the count).

or • The main controller 24 Vdc combined supply would be overloaded

WARNING: External PSU must have isolated output and comply with relevant EMC and safety standards

Check IQ3xcite 24 Vdc combined supply current availability
 IQ3 Configuration Manual TE200768

Note that the maximum current that can be flow through an I/O module using the 24 Vdc and 0 V terminals, from one module to the next, is 2.5 A.

continued next page

3 INSTALLATION (continued)

13 Connect I/O Bus (continued)

c continued

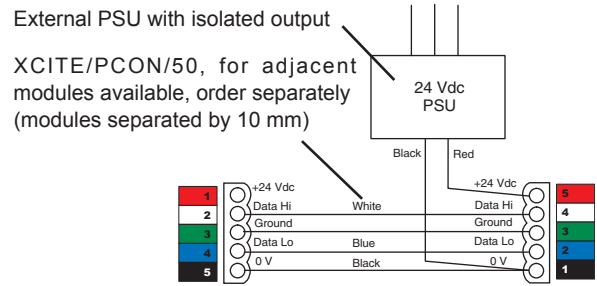
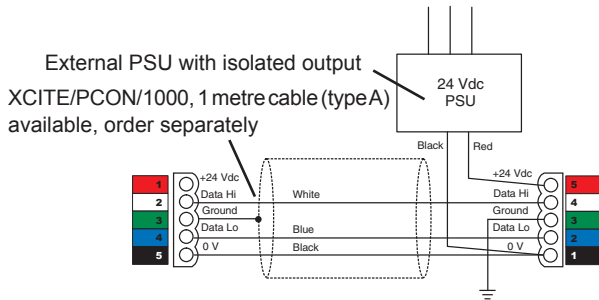

Trend can supply the PSR range of DIN rail mounted auxiliary power supplies (e.g. 1.3 A or 2.5 A). They have isolated outputs.

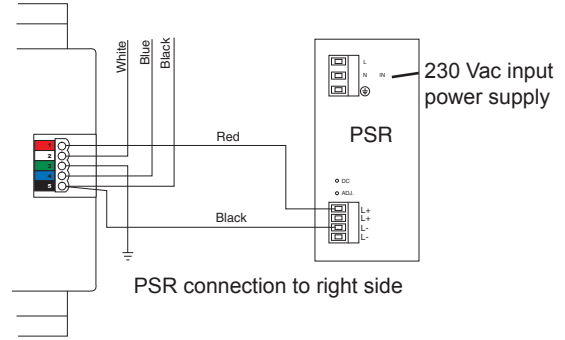
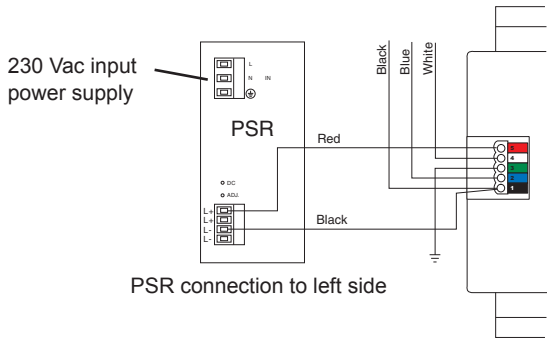

d Close flap

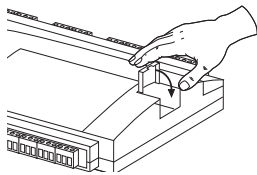

14 Terminate I/O Bus

a Open flap

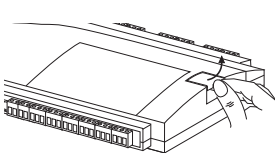

b Plug in terminator (supplied)

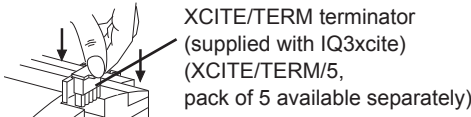

XCITE/TERM terminator (supplied with IQ3xcite) (XCITE/TERM/5, pack of 5 available separately)

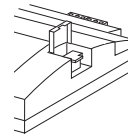

c Close flap

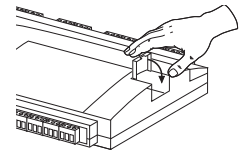

15 Configure IQ3

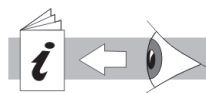

IQ3 Installation Instructions - Configuration, TG201160

4 DISPOSAL

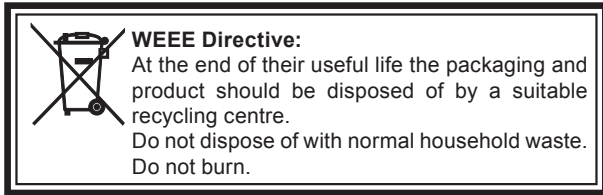

Please send any comments about this or any other Trend technical publication to techpubs@trendcontrols.com

© 2010 Honeywell Technologies Sàrl, ECC Division. All rights reserved. Manufactured for and on behalf of the Environmental and Combustion Controls Division of Honeywell Technologies Sàrl, Z.A. La Pièce, 16, 1180 Rolle, Switzerland by its Authorized Representative, Trend Control Systems Limited.

Trend Control Systems Limited reserves the right to revise this publication from time to time and make changes to the content hereof without obligation to notify any person of such revisions or changes.

Trend Control Systems Limited

Albery House, Springfield Road, Horsham, West Sussex, RH12 2PQ, UK. Tel:+44 (0)1403 211888 Fax:+44 (0)1403 241608 www.trendcontrols.com

Trend Control System USA

6670 185th Avenue NE, Redmond, Washington 98052, USA. Tel:(425) 869-3900 Fax:(425) 869-8445 www.trendcontrols.com