

## IQ3 Web Enabled Controller

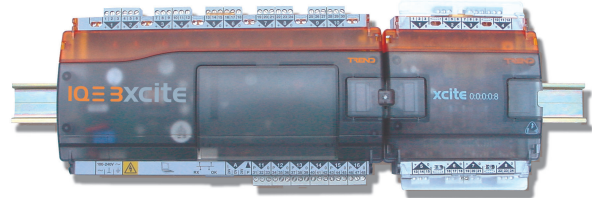

The BTL listing applies to /BAC option controllers

BACnet is a registered trademark of ASHREA. ASHREA does not endorse, approve, or test products for compliance with ASHREA standards. Compliance of listed products to the requirements of the ASHREA Standard 135 is the responsibility of BACnet International (BI). BTL is the registered trademark of BI.

### Description

The IQ3 controllers are Building Management System controllers that use Ethernet and TCP/IP networking technologies; they are optionally able to use BACnet protocol over IP. Each controller incorporates a web server which can deliver user-specific web pages to a PC or mobile device running internet browser software. If a system is set up with the correct connections, a user with the appropriate security codes can monitor or adjust the controller from any Internet access point in the world. It is also compatible with the traditional IQ system protocol. The IQ3 range consists of DIN rail mounting controllers with from zero to 16 input/output points (expandable up to 128 points by adding DIN rail mounting I/O modules). This flexibility makes them suitable for a broad range of applications. A local PC or display (SDU-xcite) can be connected to the RS232 port.

### Features

- Ethernet 10 Mbps main network with TCP/IP protocol
- embedded web server with security protected monitor/control
- embedded XML Web Services option
- BACnet over IP option (BTL Listed)
- compatible with existing IQ system protocol
- IQ3xact with 12 I/O points and IQ3xcite with 0 or 16 I/O points
- IQ3xcite with 80 or 112 additional points by DIN rail I/O modules
- I/O bus allows separate placement of I/O modules
- flexible number of software strategy modules
- RS232 local supervisor port
- 100 to 240 Vac, or 24 Vac and 24 to 60 Vdc input power supply versions
- small footprint with DIN rail mounting
- battery backup, current loop Lan, or serial auxiliary board options
- DHCP enabled.

### Physical

Diagram shows IQ3XCITE/96 or /128 (other versions may have less I/O connectors)

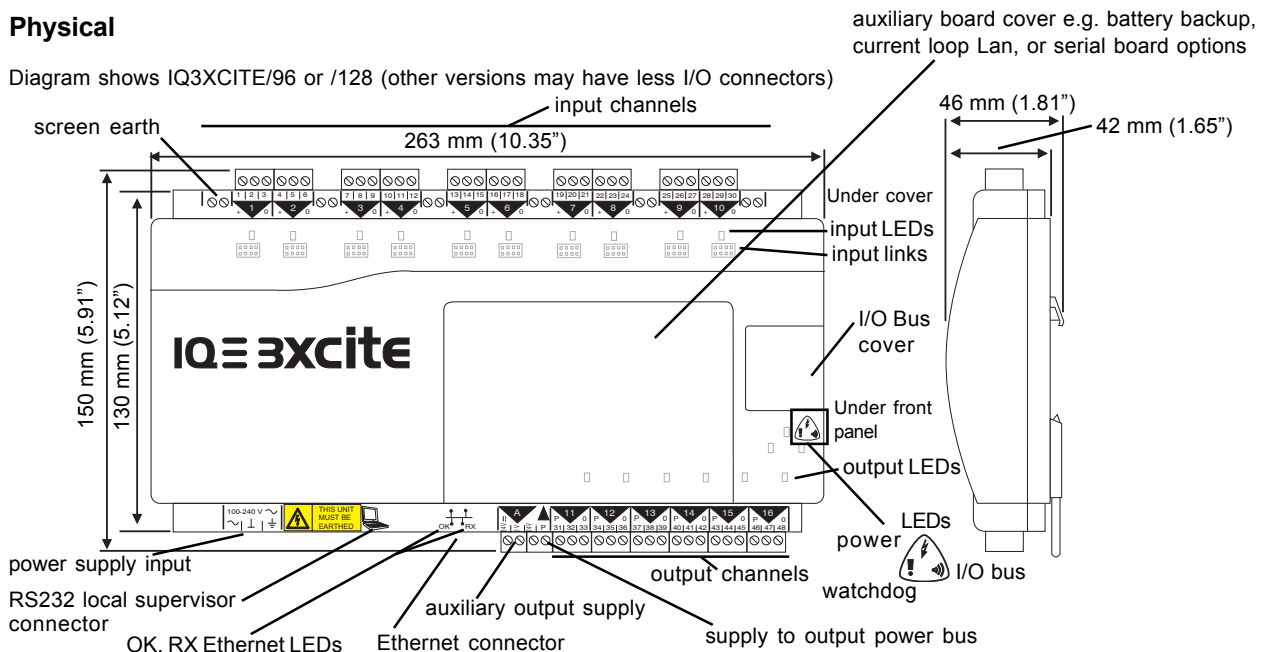

**Physical** (continued)

I/O Module (e.g. 8 universal input)

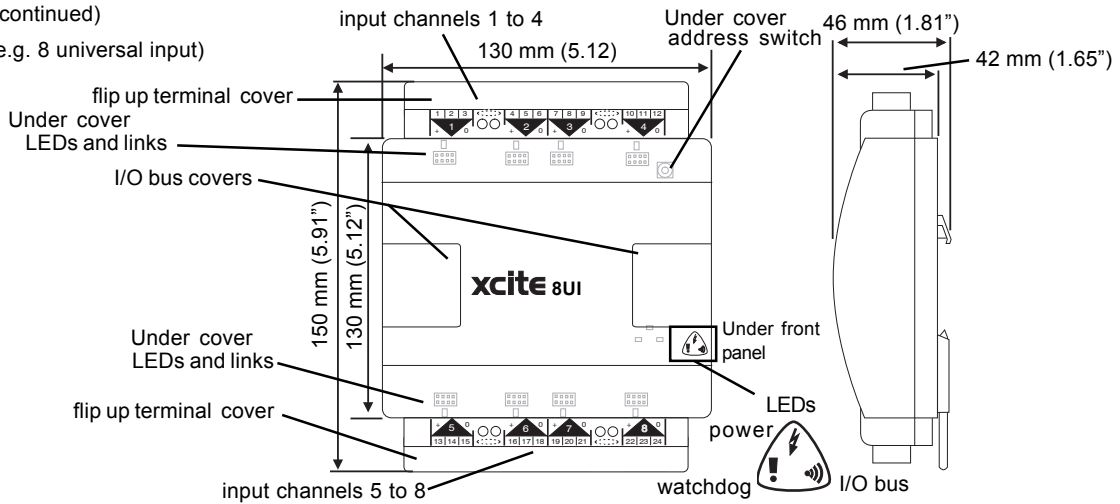

**FUNCTIONALITY**

This data sheet gives a general description of IQ3. Detailed information is given in the following manuals:

- IQ3 Configuration Reference Manual TE200768 covers IQ3's communications, hardware, configuration and all the module details
- SET Manual TE200147 covers IQ3's configuration using SET
- IQ System Ethernet Products Engineering Manual TE200369 covers the use of Trend products with Ethernet
- IQ3 Web User Guide covers the use of IQ3 Web Pages
- IP Tool Manual TE200638 describes the use of the IP Tool.
- IQ3 Graphical Display Page Editor Manual TE200629
- IQ3 Reset Applet Manual TE200767

The IQ3 functionality can be divided into four sections: system, hardware, firmware, and strategy.

**SYSTEM**

**Standard Communications**

The full standard IQ3 has Ethernet, I/O bus, and RS232 ports.

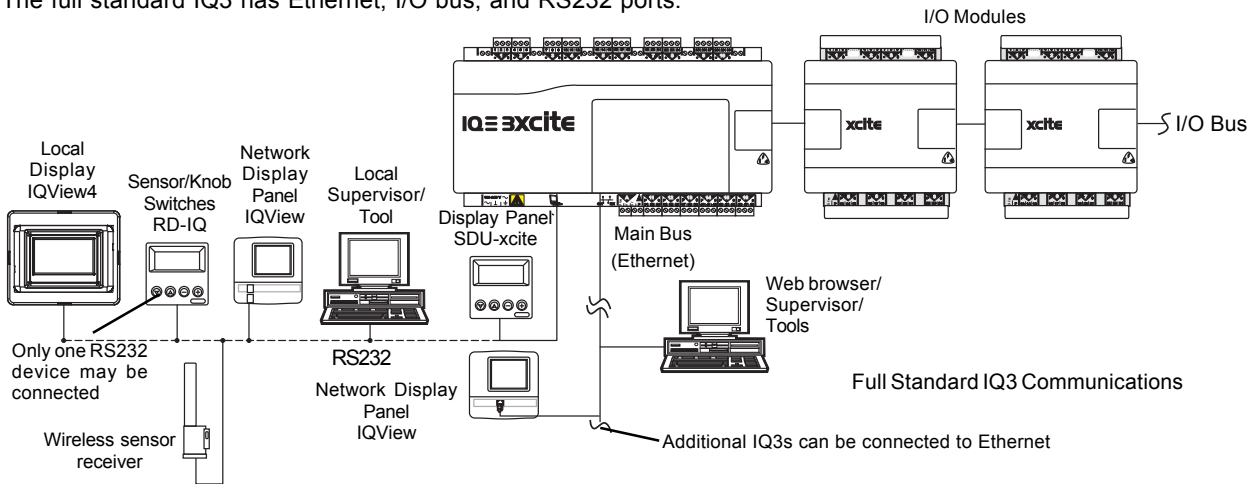

**Ethernet:** This is the main network for the IQ3 controller. It enables PCs to connect directly to Ethernet and communicate with the IQ3 using IP addressing. It also enables Inter-Controller Communications (IC Comms - peer to peer Ethernet communications) between controllers. Remote PCs can communicate through standard IT networks (e.g. the Internet) using IP, enabling communication from anywhere in the world. The IP connection will support a web browser (thin client) running in a PC, but communication with an IQ System supervisor or tool (thick client e.g. 963, IQView) will require the use of the virtual CNC embedded in the IQ3 controller. The strategy and all other configuration files may be downloaded to the IQ3 from SET (System Engineering Tool) across Ethernet.

**I/O bus:** The controller has the option of a highly reliable I/O bus. This enables expansion I/O modules to be connected to add up to 112 additional I/O points (128 points in total with the 16 points in the IQ3). The bus can be up to 10 m (11 yds) or 30 m (33 yds) in length (see page 8 for details), and have a maximum of 15 I/O modules.

**RS232 port:** A sensor/display (RD-IQ), 4 line display panel (SDU-xcite), network display (IQView or IQView4), a wireless sensor receiver (XW/R/IQ) or a local PC running a supervisor or a software tool may be connected to the RS232 port. Only one device may be connected. This port can communicate directly with the IQ3 (address 0) or to the IQ system network using the local supervisor CNC (see below). The RD-IQ or SDU-xcite communicates only with the local IQ3, so for the RS232 port to operate with RD-IQ or SDU-xcite, its address module local supervisor port address must be set to zero.

**Stand Alone Mode:** Stand alone mode can be enabled in the Ethernet IP network module. Enabling stand alone mode will stop the IQ3 from attempting to build networks with other IQ3s or EINC's, but it will still communicate as a single IQ3 (with supervisor, web browser, and local supervisor). A controller is set to stand alone mode to reduce Ethernet network traffic (i.e. to disable polling messages trying to find other Trend devices). An IQ3 prior to firmware version 1.2 could be set to 'Stand Alone' by the IP Tool. If a controller's firmware prior to v1.2 is upgraded it will be taken out of stand alone mode. It is recommended that no IQ3 controller prior to version 2.2 should be operated in stand alone mode.

**Standard Communications** (continued)

**Networks:** The IQ3 will create its own internal Lan which includes a node for its own controller, a CNC for its local supervisor port (sCNC - if supervisor port address is set non-zero), a virtual CNC (vCNC), and a virtual INC (vINC - address 126).

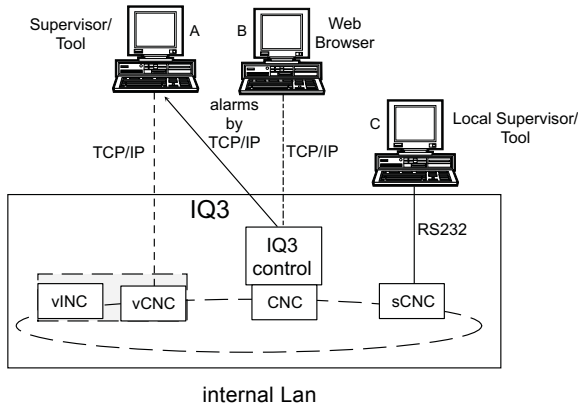

If multiple IQ3s with the same Lan number are connected to Ethernet, then an Ethernet Lan will form to include these IQ3s and their internal nodes. They must be on the same Ethernet segment, in the same subnet, and use same UDP port. The IQ3 with the lowest IP address on the Lan also assumes the INC functionality (the other vINCs disappear) and is responsible for maintaining the Lan across the IQ3s.

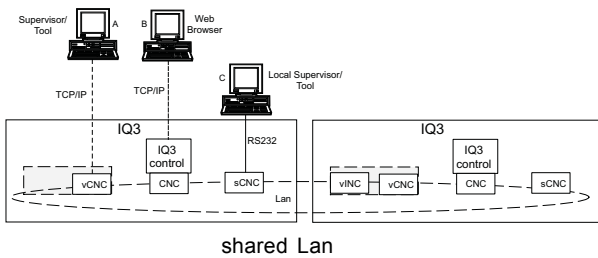

If multiple IQ3s with different Lan numbers are connected to Ethernet then their INCs will form an internetwork (along with any EINC/3xtends on the network). *Note that Trend Ethernet devices (e.g. IQ3, EINC, 3xtend/EINCL) on the same Ethernet segment must all be on the same subnet.*

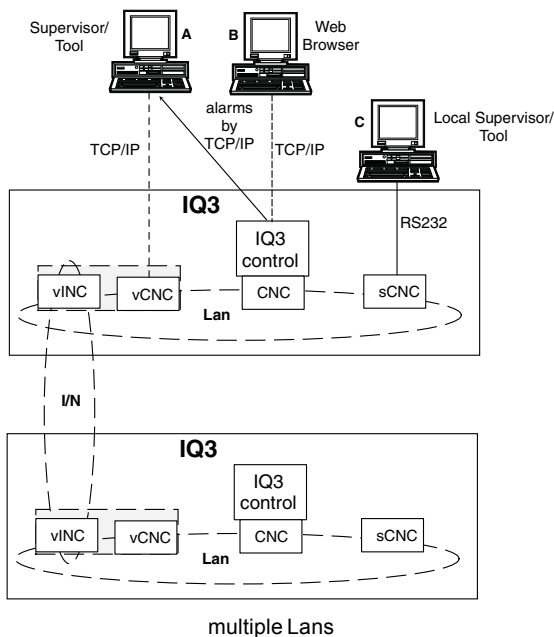

**IC Comms:** The IQ3s may communicate with each other and earlier IQ (and IQL) controllers using Inter Controller Communications (peer to peer communications). This will use IQ System Lan/node addressing (not direct IP addressing).

**Alarm Delivery:** Alarms can be delivered to the local supervisor port or to a supervisor making a permanent connection to the virtual CNC by normal IQ system comms. Alarms can be delivered to supervisors making temporary connections to the virtual CNC using TCP/IP by setting the supervisor's IP address and port number in the alarm destination module (i.e. IP alarms). Alarms may also be sent by email. *Note that network alarms are sent to any connected port (e.g. supervisor connected to local supervisor port, or supervisor connected to virtual CNC).*

**Optional Communications**

**IQ System Current Loop Lan Auxiliary Board**

The optional IQ system current loop Lan auxiliary board enables the IQ3 to become a device on an IQ system current loop Lan. It can no longer be part of an Ethernet Lan (or internetwork). However, it will still support access using a web browser or a supervisor or tool by way of a virtual CNC, and it can still send IP or email alarms across Ethernet. The current loop Lan auxiliary board is fitted in IQ3.../LAN versions of IQ3 (henceforth referred to as IQ3/LAN).

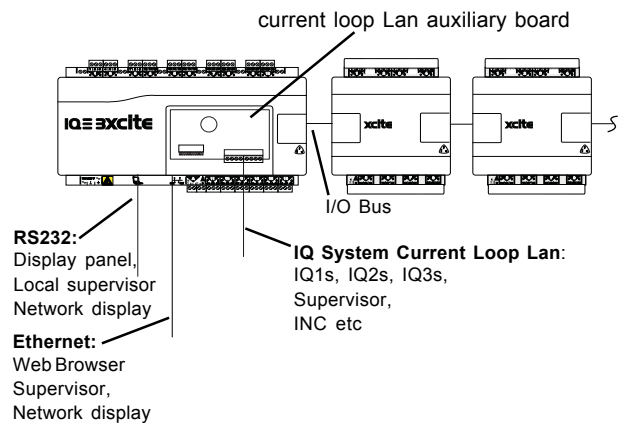

Once another IQ (IQ1, IQ2, or IQ3) is connected to the current loop, the two IQs form a Lan. This can then be extended onto an internetwork in the normal way using an INC type node (e.g. INC2, LINC, 3xtend/EINCL).

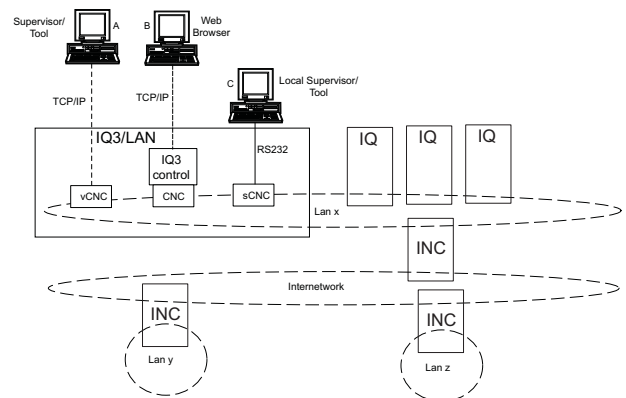

If a 3xtend/EINCL is used instead of an INC, then the internetwork (or a segment of it) can exist on Ethernet. This would enable Ethernet Lans of IQ3s to be part of the same system network as an IQ3/LAN.

## Optional Communications (continued)

### Serial Auxiliary Board

The serial auxiliary board provides an additional RS232 or RS485/422 serial port for communicating with other devices. This board is used in some versions of the IQ3../XNC/.. (referred to as IQ3/XNC/SER, see IQ3../XNC/... data sheet for more details).

### BACnet Protocol Option

IQ3/BAC versions of IQ3 support BACnet protocol; BACnet is an open protocol that enables the products of a number of different manufacturers of building automation and control equipment to communicate with each other.

Each BACnet device has a number of objects (roughly corresponding to Trend modules) and each module has a number of properties (roughly corresponding to Trend module parameters). The mapping of the BACnet properties to the Trend parameters is covered in the IQ3 Configuration Manual section 3.7.2

BACnet communications can only occur if the BACnet Network module (Network module 3, type 5) is enabled and set up as this defines the controller's communication parameters on the BACnet network.

The network module's default settings normally allow BACnet communications to operate correctly, but under certain circumstances they may need to be changed - see IQ3 Configuration Manual Pt. 2 section 20.3.4.

SET is able to browse the BACnet system, and this can be used to confirm that the IQ3's BACnet communications are operating. A specification of the objects, properties, and BIBBS (BACnet Interoperability Building Blocks) supported by the IQ3 are given in the IQ3 PICS document (Product Implementation Conformance Statement), TP201002. This describes the IQ3 functionality which is submitted to the BACnet Testing Laboratory for conformance testing.

The IQ3 controller is BTL listed as a BACnet Application Specific Controller (B-ASC) because it complies with all the BIBBS required, but it supports more than this, and on a practical system can be treated as a BACnet Advanced Application Controller (B-AAC).

**BACnet Alarms:** IQ3/BAC is able to send alarms using BACnet protocol by way of the BACnet Device type of Alarm Destination Module. This will only accept Sensor, Digital Input, Driver (digital readback), and Plot (buffer ready) alarms (other alarms will be ignored).

**BACnet IC Comms:** IQ3/BAC controllers support BACnet IC comms. This enables it to send IC Comms to a BACnet device using BACnet protocol.

The **Protocol** parameter in the IC Comms module can be set to either Trend, or BACnet.

BACnet IC Comms supports Data From, Data To, and Global To Direction Classes, but not Minimum, Maximum, Sum, or Average. The Data From, Data To, and Global To BACnet IC Comms supports Analogue and Digital Bit Variable Types, but not Digital Byte. In order to send a BACnet IC Comms a Non-Trend Device module (NTD) must be set up for the BACnet device being communicated with.

The NTD module is allocated a Lan number (for the Lan of BACnet NTDs), a node address on that Lan, and address attributes so that the controller selection process operates similarly for both Trend and BACnet protocol IC Comms. BACnet IC Comms Global To IC Comms are restricted to a specific Lan, so the Remote Lan cannot be set to 128 (signifying a global message to every Lan, i.e. a global global).

BACnet item selection is similar to that for the Trend protocol, except that BACnet variables must be specified absolutely (i.e. item selection by item label matching may not be used).

**BACnet with Automatic IP Addressing:** Certain issues exist when using automatic IP addressing and BACnet protocol. These are described in the IQ3 Configuration Manual Pt. 1 section 3.7.4

## System Configurations

**Routers:** IQ3s are able to construct an internetwork (but NOT a Lan) across a router. However, it is possible for PCs to connect to IQ3s across routers, and to treat IQ3s separated by routers as separate sites.

**Using a Supervisor with Multiple Sites:** In the diagram below there are two IQ3s either side of a router.

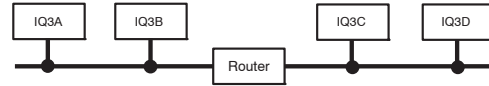

If the IQ3s are not configured to cross the router as described below, they will construct two separate networks, one each side of the router.

Only one internetwork is allowed on a site, but the Supervisor can treat the networks as separate sites and so each site may have an internetwork. The supervisor will change the IP address of the IQ3 virtual CNC it is using as it switches sites. *Note that there cannot be any IC comms between the sites.*

Alarms can be sent to the supervisor directly using TCP/IP.

**Configuring IQ3s to Cross Routers:** This is done by setting up the IQ3's network module with the 'Router 1' (default router) IP address (for a router on its own subnet) and with a Remote Device's IP address, and subnet mask (for an IQ3 on the other side of the router).

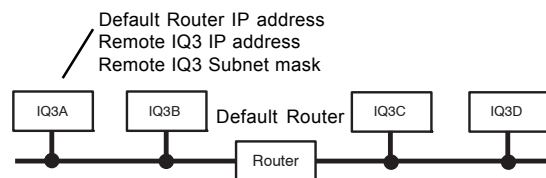

If several IQ3s are connected one side of a router, the unit with the lowest IP address (cross-router master) will attempt to construct the network across the router. In the above diagram, IQ3A is the cross-router master and is configured with the default router IP address and a remote IQ3's (e.g. IQ3C's) IP address and subnet mask. It will now send a message to IQ3C's subnet through the default router. IQ3C will then reply and the IQ3A will construct the internetwork between the two IQ3s.

Because IP addresses may not be fixed (see Automatic IP Addressing Mode - below) it may not be possible to specify which controllers have the lowest IP addresses, so the details should be set up in every device on the subnet, so that any device may be able to become the cross-router master. If Automatic IP Addressing mode is being used, the remote devices will be identified by host names rather than IP addresses.

**It is recommended that the details of two devices (either IQViews, 3xtend/EINC Ls, or IQ3s) in the network from each subnet the other side of a router should be set up in every device in the network (either IQViews, 3xtend/EINC Ls or IQ3s) on the local subnet.** For increased reliability, details of additional devices should also be set up. Note that up to 20 device's details may be entered in the network module.

**System Configurations** (continued)

**Internet Access:** Because the Internet uses TCP/IP addressing, the 963/IQ3 communication can operate over the Internet. Company Internet access is normally protected by a firewall which is usually the responsibility of the company's IT department. The firewall will need to be set up to allow messages through the port addresses being used for sending and receiving IQ System messages. Additionally the firewall may be set up either to pass messages through or to redirect them. If redirection is being used, then the messages are sent to the firewall IP address and the firewall must be set up with the relevant IQ System IP address (e.g. IQ3 vCNC, 3xtend/EINC L vCNC, or IQ3's own IP address for web pages) so it can pass them on. If using an impermanent ISP connection (e.g. using a dial up modem) at either 963 or IQ3 end, the ISP (Internet Service Provider) must support reverse dial up.

*Note that IQ3 to IQ3 networking communications will not operate across a firewall (i.e. virtual networks cannot be built across firewalls).*

**IQ3 with 3xtend/EINC L:** The diagram below shows the addition of an 3xtend/EINC L to Ethernet. The 3xtend/EINC L supports an IQ System current loop Lan which may contain IQ1 or IQ2 series controllers.

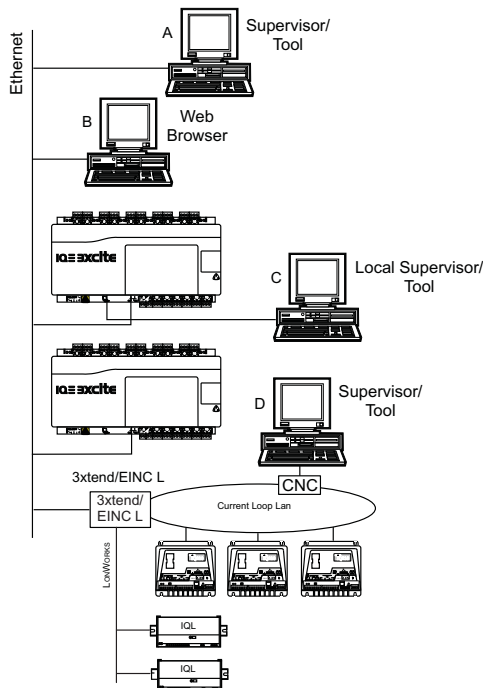

The 3xtend/EINC L differs from the EINC in that it can operate in an automatic IP addressing environment (e.g. with DHCP) and has a LONWORKS® bus connection enabling the extension of the internetwork over the LONWORKS network, and communication with IQLs.

Note that the LONWORKS network is not to be used where a high level of network traffic is expected e.g. joining internetworks or where there are many IQ system devices on many IQ system Lans being accessed across an internetwork routed through the LONWORKS network. An alternative topology should be used such as an ethernet network.

*Note that the IQ3 and the 3xtend/EINC L cannot have the same Lan number since the EINC's Lan number (set up on its address switches) is reserved for its current loop Lan.*

**IQ3 and TMN:** The IQ3 can use a TMN connected to an 3xtend/EINC L's current loop network. The 3xtend/EINC L should operate in internetwork extension mode (i.e. device address =>100) which provides a current loop internetwork with an extension on Ethernet. However, this will only give normal IQ System Communications (i.e. text communications), it cannot provide web pages.

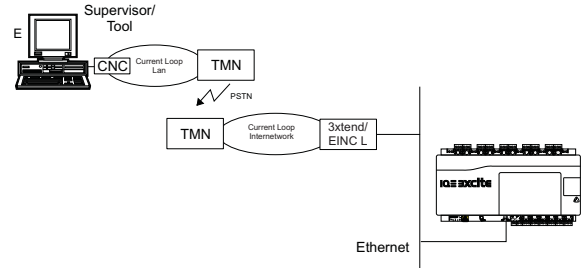

**Automatic IP Addressing Mode:** The IQ3 is able to operate in a system where the IP addresses are automatically allocated by a DHCP (Dynamic Host Configuration Protocol) server (i.e. the IP addresses are not fixed).

The IP Addressing Mode parameter (in network module) is set to **'Enter Manually'** for traditional manual entry with a fixed IP address, and is set to **'Obtain Automatically'** (default setting) for the IP address to be set automatically by the DHCP server.

**DHCP Operation:** If set to 'Obtain Automatically', when the controller powers up it will inform the DHCP server which can then provide it with:

- IP Address
- Subnet Mask
- Router 1 (default router)
- WINS Servers (1 to 5)
- DNS Servers (1 to 5)

(These parameters cannot now be changed by SET unless IP Addressing mode parameter is set to 'Enter Manually'.)

**Link/Local Operation:** If the controller is in automatic IP addressing mode and the DHCP server fails to respond, the IQ3 will enter **link/local mode** where it will negotiate its IP address with the other devices on its Ethernet segment.

A PC (running supervisor or tool software) should be set up for auto-addressing. On DHCP failure it may take a very long time to enter link/local and be able to communicate with the IQ3s. This can be avoided by power cycling the PC which will cause it to enter link/local on power up. To communicate with an IQ3 it must be on the same segment.

IP Addressing Mode	IP addressing set up by	
Obtain Automatically	<b>DHCP</b>	IP address may vary
	<b>Link/local</b>	
Enter Manually	<b>Manual</b>	IP address fixed

Summary of IP Addressing Modes

*Note that it is recommended that link/local only be used as the default method of operation on a single segment system, (not across a router).*

**System Configurations** (continued)

**Host name:** Because the IP address is no longer fixed in automatic IP addressing mode, the IQ3 a Hostname, which is fixed. When the IQ3 powers up it sends its host name to a WINS (Windows Internet Naming Service) server. If a device wishes to communicate with the IQ3 it will send the IQ3's host name to the WINS server which will return the associated IP address.

If a WINS server does not exist, the host name can be used over the local segment only (i.e. not across routers).

The host name can also be used to communicate with the IQ3 if the IP Addressing Mode parameter (in network module) is set to **'Enter Manually'**. This provides a user-friendly way of identifying the controller rather than remembering its IP address.

**Default Host Name:** If the host name has not been set up, the IQ3 will power up with a default host name which is a function of its MAC address ('Trend' plus the last six digits of the MAC address e.g. TREND\_00\_14\_D0). The default host name will always be operational (as well as its Hostname if it has been set up), unless the Default Hostname parameter (network module) has been set to 'Disabled'.

**Communication across the Internet:** If a device (e.g. supervisor) wishes to communicate across the Internet with an IQ3 on a system with automatic IP addressing, then the firewall server either has to be able to use the host name, or the IQ3's IP address must be fixed.

**Fixing the Controller's Address on a DHCP controlled System:** It is possible for the IQ3 to operate in a DHCP regime with a fixed IP address by setting up the DHCP server so that it always gives that particular IQ3 the same IP address. An alternative is to set the IQ3 IP Addressing Mode parameter (in network module) to **'Enter Manually'**, and set its IP address outside the range of the DHCP server.

**Email Server Address:** Because the Email Server Address is no longer fixed on a DHCP system, it must be set up (in the network module) to a host name or an Internet domain name. Thus when an email alarm is to be sent the Email Server IP Address is resolved by either a WINS server or a DNS (Domain Name System) server.

**Crossing Routers if DHCP is operating:** In the DHCP regime, if the internetwork is to cross a router(s), the Remote Devices (1 to 20) IP addresses should be set up as host names. This will enable the IP addresses to be obtained from the WINS servers.

*Note that if any communication using a host name crosses a router(s), then a WINS server address must be set up.*

**Servers:** If the IQ3's IP address settings are to be supplied by a DHCP server, the server must be installed on the same segment as the IQ3. On a multi-segment system a single DHCP server may be use providing it has a connection to each segment, i.e. multiple connections.

The server must be capable of downloading either or both (as appropriate, see below) the WINS server address, and the DNS server address.

If host names are being used for IP addressing across a router, then a WINS server must be installed somewhere on the system. If email alarms are being sent, and the email server address is identified by Internet domain name, then a DNS server must be installed somewhere on the system.

**HARDWARE**

**IQ3**

**Box:** The controller box is DIN rail mounting and must be fitted inside a cabinet. The input channel links are accessible by means of a clear polycarbonate cover which can be unclipped using a screwdriver. The I/O bus connector has a hinged plastic cover. The auxiliary board cover can be levered off by inserting a screwdriver between the back of the cover and the main unit. It has a rear DIN rail clip.

The digital input LEDs, the output LEDs, and the three controller status LEDs can be viewed through the clear polycarbonate.

**I/O Bus:** This feature is only available on the expandable IQ3s (IQ3XCITE/96, /128). The IQ3xcite is connected to an adjacent I/O module by a rigid connector. It can be connected to a remote I/O module by a flexible cable. The connection is made by opening the flap, plugging in the connector, and then closing the flap over the cable. The last module on the I/O bus must be correctly terminated (see I/O Modules section). The IQ3xcite is provided with a terminator, and each I/O module is provided with a rigid interconnector.

**Connectors:** Other than the screen terminals, which are single part, two part connectors are used throughout to facilitate installation. The screw terminals are of a rising cage clamp type to facilitate good connections. Each input channel has a terminal for cable screen connection. The internal cable screen earthing (grounding) terminal bus is connected to the controller earth (ground) by a soldered link on the board. If required to segregate the screen earth (ground) from the controller input power supply earth (ground), it may be connected to a separate external earth (ground) by lifting the cover and cutting the screen earth (ground) link and making a connection between the internal screen bus terminal and an external earth (ground).

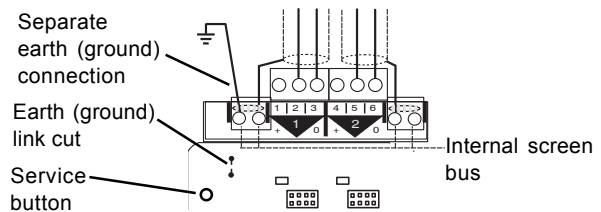

**Service Button:** The IQ3 can be restored to defaults by holding down the service button for greater than 2 s (but less than 15 s) as the IQ3 is powered up. For earlier hardware versions without the service button it can be restored to defaults by using the Reset Applet (part of SET). Note that this will clear the strategy; the data cleared down is defined in the Firmware/Strategy section below.

**Power Supply:** The IQ3 can be supplied in two input power supply versions.  
**/100-240** :100 to 240 Vac at 50 or 60 Hz. Power requirement is 56 VA maximum.

*Note that a switch or circuit breaker (240 Vac, 3 A) must be included in the supply to the unit and in close proximity to it, and it must be clearly marked as the disconnecting device for the unit.*

**/24** :24 Vac at 50 or 60 Hz, 24 to 60 Vdc (36 Vdc maximum for /UL versions). Power requirement is 40 VA maximum.

A summary of the minimum and maximum power requirements is given below:

Supply	240 Vac (nominal)		24 Vac		24 Vdc (nominal)	
	min	max	min	max	min	max
IQ3xcite/000	6 VA	15 VA	5 VA	11 VA	4 VA	8 VA
IQ3xact/012	6 VA	28 VA	5 VA	25 VA	4 VA	16 VA
IQ3xcite/016	6 VA	39 VA	5 VA	28 VA	4 VA	18 VA
IQ3xcite/096, /128	6 VA	56 VA	5 VA	40 VA	4 VA	27 VA

The minimum power is for the core electronics without any I/O auxiliary power or additional I/O modules. The maximum power for the IQ3xcite/000 includes core electronics and maximum auxiliary supply consumption, for the IQ3xact/012 and IQ3xcite/016 it also includes maximum I/O consumption; the maximum for the IQ3xcite/96 and /128 includes core electronics, maximum I/O consumption, and maximum auxiliary supply of 700 mA (which includes power to the I/O bus).

**IQ3** (continued)

**Fusing:** The 24 Vdc combined supply to the IQ3's own I/O channels, the I/O bus, the RS232 connector (e.g. to power SDU-xcite), and the auxiliary supply output is protected by a self-resetting electronic circuit breaker. The part of the 24 Vdc combined supply which supplies the RS232, and the 24 V auxiliary supply output is limited to 150 mA. The 0V return of this supply (in A terminals set) of this supply is limited at 500 mA by a self resetting fuse, so that if this 0V terminal is mistakenly used for high currents, the fuse will blow and protect the 0V line; when the fault is removed the IQ3 will return to normal operation. The analogue output P bus is protected by a 1.6 A self resetting multifuse. The power supply is protected against catastrophic failure by a non-replaceable fuse. The analogue output circuitry is protected against the wrong connection of a non-isolated external supply by a non-replaceable fuse. If either non-replaceable fuse blows, the controller should be sent back for repair. The I/O modules have protection as described in the I/O module section.

**Battery Backup:** The strategy configuration and data (logs, alarms) are stored in the unit in nonvolatile memory (Flash). A 'supercap' is used to maintain the real time clock (time and date). In the event of power failure this will support the clock for 6 days (typically). Note that the supercap needs about 2 minutes to reach full charge after power is applied. Optionally a battery board (XCITE/BBC) can be fitted into the unit; this will support the clock for several years in the event of power failure (e.g. for Timemaster, see Firmware/Timemaster). If the battery hasn't been discharged, it should be replaced routinely every 5 years. The battery (type CR2032) can be replaced after turning the power off and removing the auxiliary board cover (while the battery is not in circuit the supercap will maintain the real time clock).

**IQ system Current Loop Lan Optional Auxiliary Board:** The IQ3/LAN (IQ3../LAN) is supplied complete with a Lan auxiliary board fitted in the auxiliary board slot, and with a special auxiliary board cover which enables access to the auxiliary board switches and connectors.

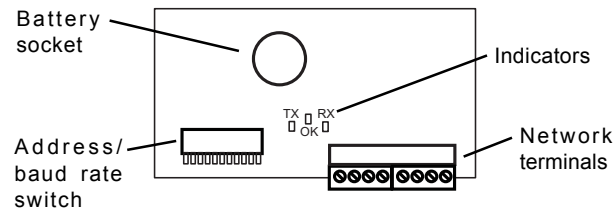

The auxiliary board also contains the circuit for a backup battery so it can also fulfil the function of XCITE/BBC as described above. However, the CR2032 battery is not supplied so must be purchased separately if a battery backup option is required. The board contains the normal hardware for an IQ system current loop Lan node:

**Address/Baud rate switch:** The address on the Lan is set by poles 1 to 7 in range 1, 4 to 9, 11 to 119 and must be unique on the Lan. The strategy address module Local Address parameter monitors the address switch settings and is read only for IQ3/LAN. The baud rate is set by poles 8 to 10 in the range 9k6, 19k2 and must match the other nodes on the Lan (it can also be read in Network Module 2).

*Note that zero address reset is not implemented on IQ3.*

**Network terminals:** The network terminals facilitate connection of 4 wire cables (enabling a 'weaving' connection method).

**Indicators:** The standard LEDs are fitted (TX, RX, and network OK).

**Bypass relays:** The board contains 2 changeover relays which bypass the receive and transmit circuitry and maintain network integrity during power fail.

**Serial Auxiliary Board:** This board is fitted to IQ3/XNC/SER (IQ3../XNC/SER) versions of IQ3, see IQ3../XNC/... data sheet for details. This board also supports the battery backup facility in the same way as the IQ system current loop Lan auxiliary board (see above).

**Indicators:**

**I/O Channels**

**Input LEDs: (yellow)** Each input channel has an LED to monitor the input state when the input channel is set to a digital input. The LED will illuminate when the associated input contact is closed.

**Output LEDs: (yellow)** Each output channel has an LED whose light intensity increases with output voltage.

**Core function**

**Watchdog (W): (red)** On if controller has a software fault (i.e. strategy or firmware).

**I/O bus error (E): (red, not fitted on IQ3xact)** On if there is an I/O bus fault, (e.g. check for short circuit between Data Hi or Data Lo and either of the power lines).

**Power (P): (green)** On when input power supply is connected. Flashes briefly at 1 second intervals if input power supply fault; return unit to supplier.

**Ethernet**

**OK : (green)** Normally called LINK on Ethernet systems. ON indicates a good Ethernet connection. If OFF indicates faulty Ethernet connection.

**RX: (yellow)** Flashes when packet of data is being received across the Ethernet.

**24 Vdc Combined Supply:** The 24 Vdc combined supply supplies the IQ3's own input/output channels, the I/O bus, the RS232 connector (e.g. to power SDU-xcite), and the 24 Vdc auxiliary output supply terminals. The total available current is 700 mA (reducing to 550 mA for /100-240 version if the 230 Vac input power supply is less than 200 Vac). The PSU has thermal overload protection and the combined supply is protected by a self resetting electronic circuit breaker.

The input and output channels are current limited at 22 mA each. The part of the combined supply used by the RS232 connector and the auxiliary output supply is current limited to 150 mA (typical). The auxiliary output supply can be linked into the P connector to supply auxiliary power for use by output devices.

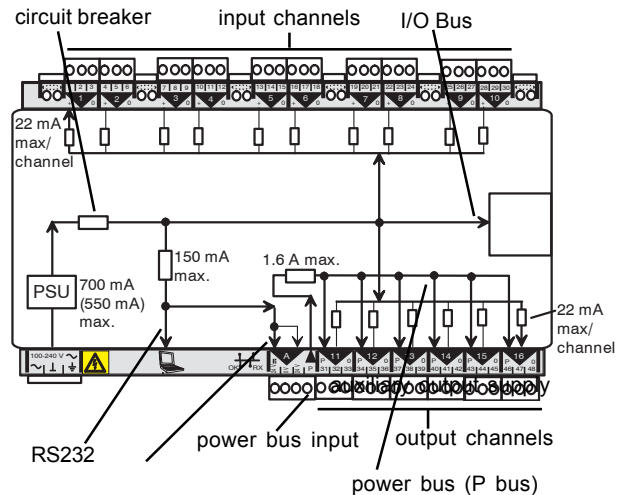

The P output terminals are used to supply the power to output devices. The internal power bus (P bus) is protected by a 1.6 A self-resetting multifuse. The power bus input terminal is normally supplied from the IQ3 24 Vdc auxiliary output supply by using an external link but it can be supplied from an external, dedicated, isolated, 24 Vac/Vdc power supply. The controller is protected against the wrong connection of a non-isolated external supply by a non-replaceable fuse.

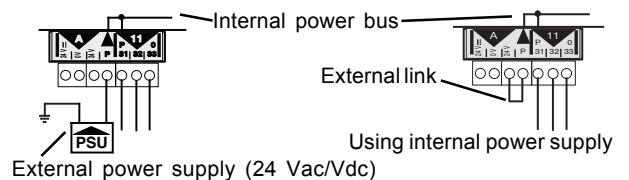

**IQ3** (continued)

**24 Vdc Combined Supply** (continued):

Note that if an external 24 Vac/dc power supply is used, it must be dedicated to I/O channel use, and it must comply with the relevant EMC and safety standards.

The external supply can be either 24 Vac or 24 Vdc, but if the output devices require a mix of 24 Vac and 24 Vdc a decision will have to be made over which supply to connect to the P bus; the other supply will need to be provided by external wiring.

Note that the installer should note whether the P bus is 24 Vac, or 24 Vdc and only connect the appropriate loads.

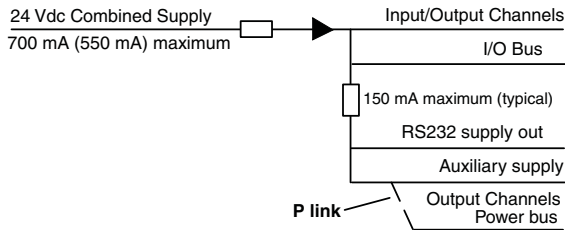

The following checks should be made:

- The maximum current 700 mA (550 mA) available from 24 Vdc combined supply is not exceeded.
- The 150 mA supply to the RS232 and Auxiliary output supply is not exceeded.

The calculation to perform these checks is described in the IQ3 Configuration Reference Manual TE 200768 section 4.2.12.

**I/O Channels:**

The various models of IQ3 have differing numbers of I/O channels as shown below:

- IQ3XCITE/00: Zero input/output channels
- IQ3XACT/12: 6 universal inputs and 6 analogue outputs
- IQ3XCITE/16: 10 universal inputs, and 6 analogue outputs
- IQ3XCITE/96, /128: 10 universal inputs, and 6 analogue outputs plus additional I/O channels can be provided by connecting I/O modules to the I/O bus to provide up to a maximum of 96 or 128 channels.

**Universal Inputs**

Channels 1 to 10 - linkable for digital (D), current (I), thermistor (T), or voltage (V) inputs.

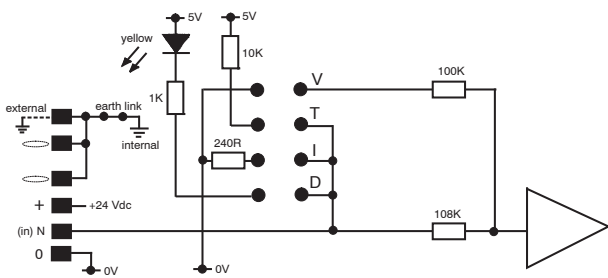

For D, I<sub>x</sub>, V, and T connect between (in)N and 0 V.  
For I<sub>L</sub>, connect between 24 Vdc and (in)N.

Links:

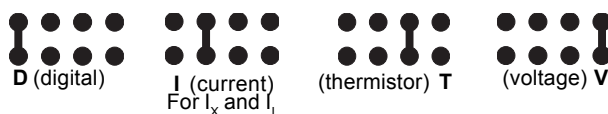

Digital inputs may be volt free contact, logic, or open collector (or drain) connected as shown in the I/O module channels section.

**Analogue Voltage Outputs**

Channels 11 to 16.

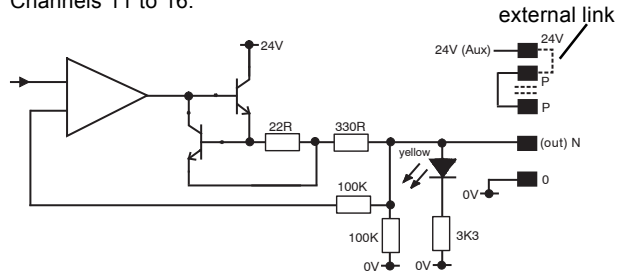

The P output terminals are used to supply power to the output devices. The internal power bus (P bus) is protected by a 1.6 A solid state self-resetting multifuse. The P bus is normally supplied from the IQ3 24 Vdc auxiliary output supply through the external link shown above (supplied fitted by default) but if required it can be supplied from an external isolated 24 Vac/Vdc power supply. The controller is protected against the wrong connection of a non-isolated external supply by a non-replaceable fuse.

**Ethernet:** The controller should be connected to an Ethernet hub or switch using Cat 5e unshielded or shielded (UTP or FTP) cable and RJ45 plugs (shielded or unshielded appropriate to the cable).

A local PC (Ethernet) can either be connected to an adjacent port on the hub, or can be connected directly to the IQ3 Ethernet port using a standard Ethernet cable in conjunction with a crossover adaptor (XCITE/XA).

**Displays**

The IQ3 controller can be used with IQView, IQView4, SDU-xcite, and RD-IQ displays.

Note that the NDP is not compatible with IQ3; it will not recognise an IQ3 connected to its network.

**IQView:** The IQView is a touch screen network display (colour or mono) which can be either surface mounted or rear panel mounted. In addition to showing all the normal strategy items, it can access directories, timezones, and alarms, and users can be set up with configurable access rights. It can be connected to the IQ3 either by Ethernet or by RS232. The Ethernet connection can either be by the IQView's own virtual CNC or by an external vCNC (e.g. the IQ3's). The RS232 connection enables the IQView to communicate either only with that IQ3 (if local supervisor port address is zero), or with the network (if local supervisor port address is non-zero).

**IQView4:** The IQView4 is a touch screen colour display panel for rear panel mounting with a front cover. It can access inputs, outputs, alarms, and plots, and allows knobs, switches, timezones and time to be adjusted. Users can be set up with configurable access rights. It connects to the IQ3 by its RS232 port, and it can communicate only with that IQ3, so the local supervisor port address must be set to zero.

**SDU-xcite:** The SDU-xcite is a wall mounting 4 line display. In addition to showing all the normal strategy items, it can access directories and the IQ3's alarm log. It connects to the IQ3 by its RS232 port, and it can communicate only with that IQ3, so the local supervisor port address must be set to zero.

**RD-IQ:** The RD-IQ is a wall mounting temperature sensor and 3 digit display. It has the following variants:

**RD-IQ/K:** Room display with local temperature sensor and setpoint control

**RD-IQ/KOS:** As RD/K plus occupation override and occupation status display.

**RD-IQ/KOSF:** As RD-IQ/KOS plus fan speed control.

It connects to the IQ3 by its RS232 port, and it can communicate only with that IQ3, so the local supervisor port address must be set to zero. By default it accesses fixed strategy items (although these can be changed using the front panel buttons or SDU configuration software, SDU Tool):

- Local temperature S9
- Setpoint K1
- Occupation status K6
- Fan speed status K7

I/O Modules

The expandable versions of the IQ3 (IQ3XCITE/96/... /128/...) have the option of connecting additional I/O modules to the I/O bus.

- A maximum of 15 I/O modules can be connected.
  - A maximum of 96 or 128 points (16 points in the IQ3xcite and 80 or 112 expansion points) can be used.
  - The controller and its I/O modules are to be fitted inside enclosures.
  - No spurs are allowed on the I/O bus.
  - If a single fully earth (ground) screened and bonded contiguous metal enclosure is used, then the total I/O bus cable length can be up to 30 m, 33 yds (this covers the use of a multiple section electrical control cabinet e.g. Form 4 enclosures). However, if any other type of enclosure is used, or the I/O bus runs between enclosures, then the total I/O bus cable length can be up to 10 m, 11 yds.
- (For the calculation of cable length, rigid interconnectors can be ignored.)
- Multiple enclosures must be earthed (grounded) to a common earth (ground) point according to latest IEE regulations.

The current range of modules consists of:

- 8 Universal Inputs (/8UI)
  - 4 Universal Inputs (/4UI)
  - 4 Universal Inputs and 4 Analogue Voltage Outputs (/4UI/4AO)
  - 2 Universal Inputs and 2 Analogue Voltage Outputs (/2UI/2AO)
  - 8 Relay Outputs (/8DO)
  - 4 Relay Outputs (/4DO)
  - 8 Analogue Outputs (/8AO)
  - 4 Analogue Outputs (/4AO)
  - 16 Digital Inputs (/16DI)
  - 8 Digital Inputs (/8DI)
  - 8 Digital Inputs and 8 Thermistor Inputs (/8DI/8TI)
  - 8 Relay outputs with Hand/Off/Auto (/8DO/HOA)
  - 4 Relay outputs with Hand/Off/Auto (/4DO/HOA)
- Layouts of the I/O modules are shown in the IQ3 Configuration Reference Manual TE200768 section 4.3.1.

**I/O Bus:** The I/O module has a hinged plastic cover each side for connection of the I/O bus, enabling the bus to be daisy chained by the I/O modules. A short rigid interconnector (XCITE/IC) is available for adjacent modules. An interconnector is supplied with each I/O module; spare interconnectors are available (XCITE/IC/5 pack of 5).

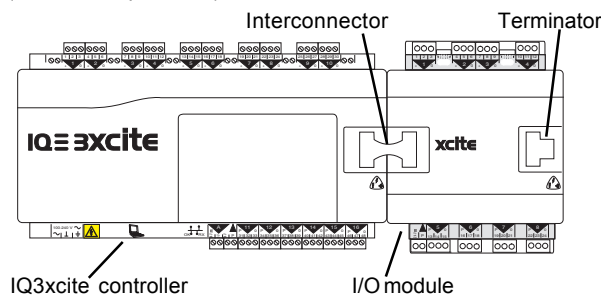

The bus should be terminated at the furthest end from the controller between Data Hi and Data Lo terminals with a 122 Ω resistor. A terminator is supplied with the IQ3xcite controller, and spare terminators (XCITE/TERM/5 - pack of 5) are available.

The rigid bus interconnector includes a ground connection.

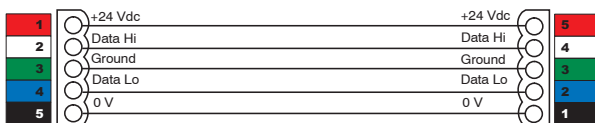

For modules further apart within a metal enclosure, plug in screw terminals (XCITE/CC/10 - pack of 10) are available, enabling the modules to be wired together. Belden 3084A cable should be used, the ground connector should be earthed (grounded) locally, and the cable screen should be grounded at the controller end.

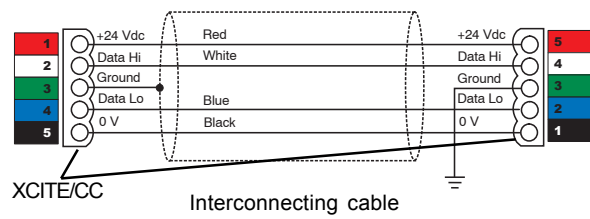

Note that the cable core colours shown are for the recommended cable, Belden 3084A.

This type of cable connects the right side of one module to the left side of another. It can be used for two sections of DIN rail in a panel as shown below:

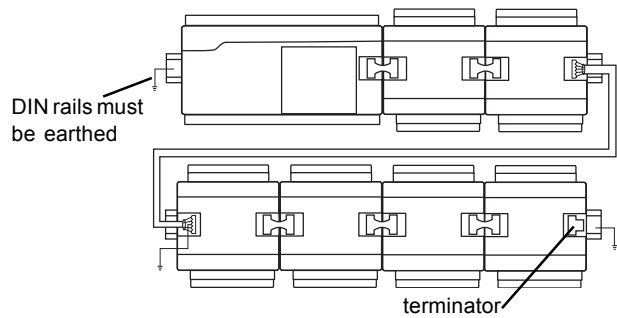

Use of cable to interconnect 2 sections of DIN rail

A different cable must be used if the connection is between the same side of each controller as one connector is rotated due to polarisation of the connectors.

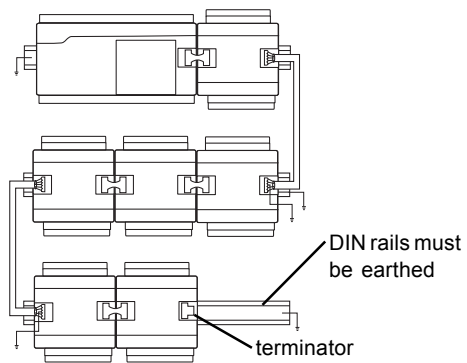

No spurs are allowed. For example, in the multisection panel below the DIN rail sections are connected in series to form one single length of bus with termination at the farthest end from the controller.

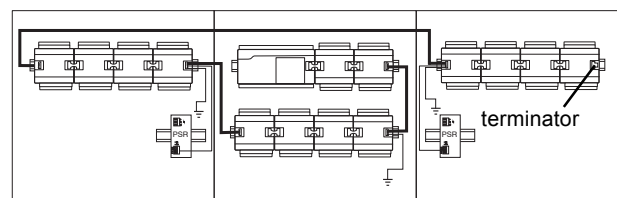

Multisection panel with single length bus

The IQ3xcite can supply 24 Vdc to the I/O modules through the I/O bus 24 Vdc terminal. The available current from the controller's combined 24 Vdc supply can be calculated as described in the IQ3 Configuration Reference Manual section 4.2.12.

**I/O Modules** (continued)

Alternatively an external 24 Vdc supply must be used if:

- There are more than 6 I/O modules\*
- The main controller combined supply would be overloaded.

\*Note that this rule does not apply to /8AO, /4AO, /16DI, /8DI, /8DI/8TI, /8DO (serial number M3D4 C0 508 012 or greater), /4DO (serial number M3D8 C0 508 0136 or greater), /8DO/HOA, /4DO/HOA modules which do not need to be included in this module count.

The maximum I/O module currents are listed in the table below: these can be used to estimate the total current required by the I/O modules. A more accurate current consumption can be calculated as described in the I/O module 24 Vdc supply section below.

Module	Module	Module
8DO: 100 mA	4UI/4AO: 180 mA + Aux supply max 150 mA	16DI: 36 mA
4DO: 60 mA	2UI/2AO: 100 mA + Aux supply max 150 mA	8DI: 28 mA
8UI: 180 mA	8AO: 180 mA + Aux supply max 300 mA	8DI/8TI: 30 mA
4UI: 100 mA	4AO: 100 mA + Aux supply max 150 mA	8DO/HOA: 100 mA
		4DO/HOA: 60 mA

If an external supply is required, the normal bus connection between 24 Vdc terminals is not made, instead an isolated 24 Vdc supply is wired between the 24 Vdc and 0V terminals.

The maximum current that can be passed through an I/O module through the 24 Vdc and 0 V terminals, from one module to the next, is 1.6 A.

Note that if an external 24 Vdc power supply is used, its output must be isolated from earth (ground), and it must comply with the relevant EMC and safety standards.

For adjacent modules the XCITE/PCON/50 cable facilitates the connection of the external power supply; it leaves a 10 mm (0.39") gap between the modules.

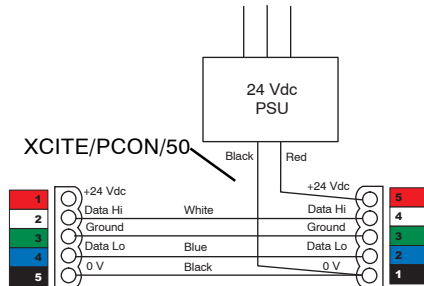

For non adjacent modules the following connections should be used. This is facilitated by XCITE/PCON/1000, a 1 metre (1 yd 3") cable.

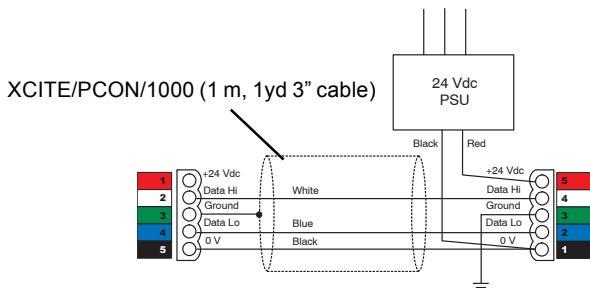

The PSR range of DIN rail mounted auxiliary power supplies (e.g. 1.3 A, 2.5 A, or 5 A) are available. They have isolated outputs.

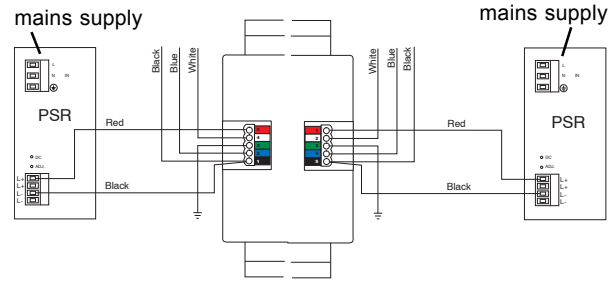

PSR connection to left side PSR connection to right side

Consideration should be given to the maximum current flowing through from one I/O module to the next as this must not exceed 1.6 A. An example of the calculation of maximum current is given in the IQ3 Configuration Reference Manual TE200768 section 4.3.6

**I/O Module 24 Vdc Supply:** An I/O module can either take its supply from the main controller or from an external supply as described above.

Maximum current consumptions were given in the table above, but a more accurate current consumption may be required to decide whether an additional power supply is required to supply the I/O module or to supply the P bus.

The I/O bus connector 24 Vdc terminal supplies the I/O module's core electronics, its input/output channels, and the 24 Vdc auxiliary supply terminal (present only in I/O module with analogue output channels) which is limited to 150 mA (typical). The auxiliary supply is provided so that it can be linked into the P connector to supply auxiliary power for use by output devices.

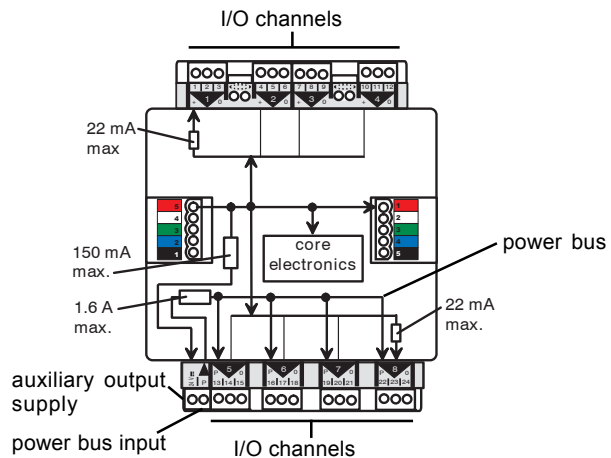

Just as for the main controller, on I/O modules with analogue outputs the P output terminals can be used to supply the power to output devices. The internal power bus (P bus) is protected by a 1.6 A self-resetting multifuse.

The P bus can be externally supplied by a dedicated, isolated, 24 Vac/Vdc power supply, or can be supplied from the I/O module's 24 Vdc auxiliary output supply by using an external link. The I/O module is protected against the wrong connection of a non-isolated external supply by a non-replaceable fuse.

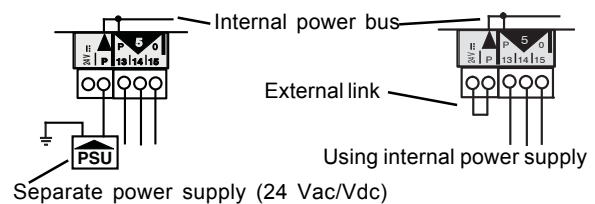

**I/O Modules** (continued)

*Note that if an external 24 Vac/dc power supply is used, it must be dedicated to I/O channel use, and it must comply with the relevant EMC and safety standards.*

The external supply can be either 24 V ac or 24 Vdc, but if the output devices require a mix of 24 Vac and 24 Vdc a decision will have to be made over which supply to connect to the P bus; the other supply will need to be provided by external wiring. *Note that the installer should note whether the P bus is 24 Vac, or 24 Vdc and only connect the appropriate loads.*

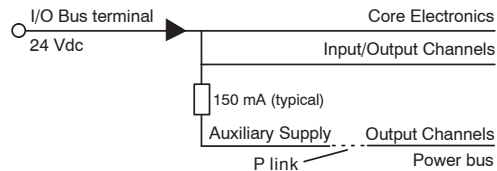

The following checks should be made:

- Calculate the maximum current consumed from the I/O bus 24 Vdc terminal for use in the main controller's auxiliary calculation.
- Check that the 150 mA supply to the Auxiliary Supply is not exceeded.

The calculation to perform these checks is described in the IQ3 Configuration Reference Manual TE 200768 section 4.3.7.

**I/O Module Enclosure:** The I/O module enclosure is DIN rail mounting and must be installed in a cabinet. It has clear polycarbonate covers over both the upper and lower terminal sets to enable access to the channel links and the address switch. The strips can be unclipped using a screwdriver and clipped back in position after use. The I/O terminals are protected by clear polycarbonate flip up safety covers. It has a rear DIN rail clip.

The digital input LEDs, output LEDs, and the three controller status LEDs can be viewed through the clear polycarbonate.

**Screen Earthing (Grounding):** On I/O modules with universal inputs, the screens for universal input channels are normally connected to the module ground, but they may be separately earthed-grounded (if required to segregate the screen earth-ground from the I/O module ground).

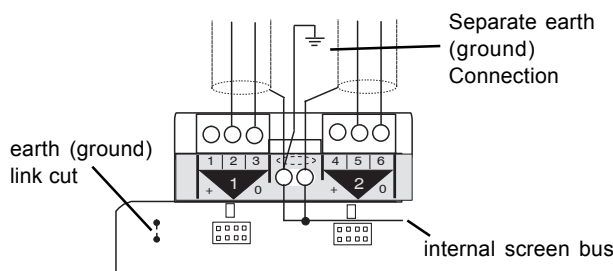

This is similar to the controller screen earthing (grounding), see IQ3, connectors section. There is a separate link for each group of four channels (i.e. the 8 universal input module has two links).

**I/O Module Address Switch:** The address switch consists of a hexadecimal switch, 0 to 9, A, B, C, D, E, F. Selecting address zero disables the module. If there is an address clash on the I/O bus, the I/O bus fault LEDs on all the modules with the same address will flash; a module's address can be corrected by setting its address switch to other addresses until its LED stops flashing.

When setting up the input and output channels in sensor, digital input, and driver software strategy modules, the I/O module address and the channel number have to be entered; the main controller is referred to as module zero.

**I/O Module Channels:** The universal inputs have similar connections to those in the main IQ3xcite.

**Analogue Outputs:** The analogue outputs have a similar arrangement to the main controller with the 24 Vdc auxiliary output supply and the P bus. The /8AO auxiliary output supply terminals can supply a maximum of 300 mA (shared between both sets of terminals); if this is exceeded the current limits and the two Excess Aux. Current LEDs (red) will illuminate. The /4AO can supply a maximum of 150 mA and it has one Excess Aux. Current LED (red) which will illuminate if this limit is exceeded.

**Relay Outputs:** The relay outputs are single pole changeover, and have a relay output status LED (yellow) which is ON when the relay is energised.

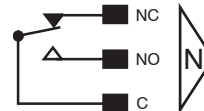

**Relay Outputs with Hand/Off/Auto:** The relay outputs with Hand/Off/Auto (HOA) facility are based on the standard relay outputs but also have a 3 position HOA switch per channel. This switch can be set to Hand (H, manually overridden ON), Auto (A, under automatic control from the strategy), or Off (O, manually overridden OFF). In addition to the yellow output status LED there is a red LED which is ON when the output is manually overridden (i.e Hand or Off). The output status LEDs are nearest to the terminals and the overridden LEDs are towards the centre of the unit. The output can thus be in one of four states which are shown in the table below along with the switch and LED states.

State	Switch Position	Relay State	Overridden LED (red)	Output LED (yellow)
Manually overridden ON	Hand	ON	ON	ON
Manually overridden OFF	Off	OFF	ON	OFF
Automatic ON	Auto	ON	OFF	ON
Automatic OFF		OFF	OFF	OFF

The HOA switch position is fed back to the IQ3 strategy driver module from where it can be viewed using webpages, SET, or supervisors.

**Digital Inputs:** The digital input circuit used in the /16DI and /8DI modules enables the use of a volt free contact input (like the universal input, digital input), but also of an open collector, 24 Vac, or logic input.

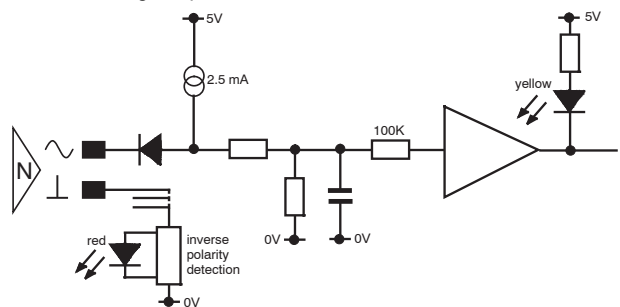

The input will be on when the input LED (yellow) is ON, and this is when the contact closes or AC voltage is applied. This corresponds to an open collector transistor or an open drain FET being ON, or a logic input sinking current from the ~ terminal (low state).

There is an Input Polarity Error LED for each bank of 8 inputs. This LED (red) is ON if one (or more) of the digital inputs are supplied by an ac voltage, which has been grounded on the wrong side with respect to the IQ3's ground.

**I/O Modules** (continued)

**I/O Module Channels** (continued):

The various digital input connections are shown below:

**Volt Free Contact Input**

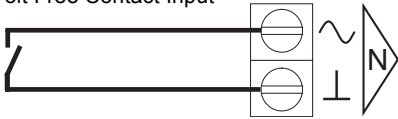

The volt free contact input has a nominal wetting current of 2.5 mA. The input is ON when the contact is closed..

**Logic Input**



The logic high level can be between 5 and 50 V (e.g. TTL, CMOS). The logic low level must be able to sink 3 mA. Note that the digital input will be ON when the logic input is low.

**Open Collector (or Open Drain) Input**



This can be an open collector or an open drain (FET) input. The collector or drain must be able to sink 3 mA. When the transistor or FET conducts, the digital input will be ON.

**24 Vac Input**

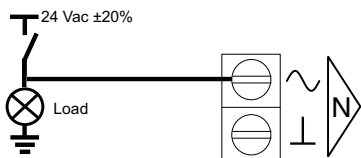

This type of digital input can monitor the state of a 24 Vac signal. In this example it will be ON when the load (e.g. a fan) is powered. For the above configuration the load impedance must exceed 1.6 kohms (e.g. an LED); if it does not (e.g. filament lamp or relay coil) then a 1.6 kohm resistor should be fitted in series with the input.

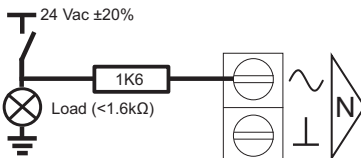

**Thermistor Inputs:** The I/O module thermistor input is similar to a Universal Input linked for thermistor (T). However, there are only 4 screen terminals located 2 at each end of the terminal row.

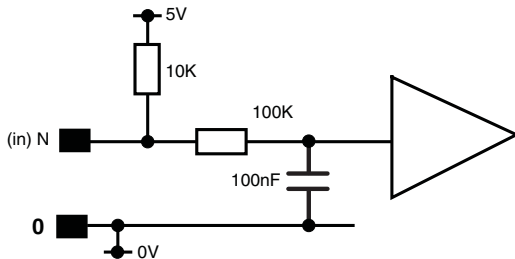

**Indicators:** The I/O modules have similar indicators to the controller: Universal input (digital), Analogue output, Power, and Watchdog. The Relay output, Analogue output (/8AO, /4AO) Excess Aux. Current, Digital input (/16DI, /8DI), and Input Polarity Error indicators are described above.

The I/O Bus LED will illuminate continuously for an I/O bus fault (e.g. check for short circuit between Data Hi or Data Lo and either of the power lines). If the LED flashes at 1 second intervals, the I/O module has not been in receipt of any valid comms for 30 secs, and the module will switch off any outputs.

If the LED flashes faster it indicates an address clash as described above (I/O Module Address Switch); this duplicate address check is done after power up or after changing the address switch.

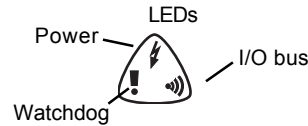

**FIRMWARE**

**Upgrade**

The firmware in the IQ3 CPU board, baseboard, and XCITE I/O modules can be upgraded over Ethernet.

**XML Web Services**

'XML Web Services' is a field-upgradeable option. It can be added to any IQ3 variant by purchasing the XML Web Services Upgrade (IQ3XACT/XML/UP for IQ3xact, and IQ3XCITE/XML/UP for IQ3xcite). This will entitle the purchaser to obtain an unlock code for Trend Technical Support. In order to operate, the XML Web Services should be enabled in the Ethernet IP network module.

XML is a general purpose specification for creating custom markup languages. It helps developers create web pages and also provides a basic syntax that enables information to be shared by different computers and applications. The IQ3 XML syntax is described in the IQ3 Configuration Manual.

**Strategy**

The IQ3 strategy modules are based on the traditional IQ paradigm with minor changes to increase capability and efficiency. The .IQ3 strategy file is created and downloaded using SET. SET facilitates strategy creation by providing an indexed library of pre-configured strategy blocks or custom solutions (entire controller strategies); these may be viewed, printed, or edited to suit the user.

Once the strategy is complete it can be tested prior to download by using the SET controller simulator mode.

The strategy file and the other configuration files (language, backdrop, and XNC (IQ3/XNC only)) can be downloaded or uploaded across Ethernet (FTP) but only the strategy file can be downloaded or uploaded across the current loop Lan (IQ3/LAN only) or the RS232 port.

An Ethernet download requires the PC running SET to be connected to Ethernet, and to communicate with the IQ3 using the IQ3's IP address (SET will actually obtain the IP address from the IQ3 using the IQ System Lan number and device addresses). Attempts to download a BACnet strategy file to a non-BACnet IQ3, or an XNC strategy file to a non-XNC IQ3 will fail and will result in a Feature Error Program State being declared in the Program module.

As explained in the hardware section above, the IQ3 can be restored to defaults by pressing the Service Button or by using the SET Reset Applet (e.g. to recover from a lost PIN when the user hasn't recourse to Trend Technical Support).

This will clear down strategy files and the XNC application file. It will restore the following strategy data to defaults (Lan number, outstation address, IP addressing mode, IP address, subnet mask, UDP port, identifier, Router 1, remote Trend devices, vCNC). It will clear all user modules (passwords, PINs etc), alarm logs, and plots. It will leave untouched the backdrop and language files, and leave Time and Date at their current settings. After the reset the IQ3 should be reconfigured from scratch and the strategy downloaded.

The IQ3 web server provides pages (HTML) which enable limited configuration from a web browser; most module parameters may be viewed and adjusted, but the strategy structure (module interconnections, adding or deleting a module) cannot be modified from a web browser.

**Addressing**

Each IQ3 has a unique MAC (Media Access Control) address allocated to its Ethernet node. The IP Tool (SET auxiliary application) enables the IQ3 IP address (and other Ethernet parameters), and the IQ System Lan number and device address to be set up.

The IP Tool can automatically fetch the details of all the IQ System IP devices (3xtend/EINC Ls and IQ3s) on its own segment of Ethernet; it can also fetch details from devices the other side of a router by reading the remote Trend Device modules from an IQ3 or 3xtend/EINC L (alternatively the user can enter the remote device's IP address by hand).

The IP Tool also enables the virtual CNCs to be configured.

**Strategy Modules**

**Modules:** In the IQ3 the number of each type of module may be adjusted to match the requirements of the application as long as the memory capacity of the controller is not exceeded. As a general guideline the IQ3/96 has a capacity at least equal to a fully utilised IQ251.

The available capacity is measured in brIQs. The total available capacity in an IQ3 varies with the type and is given in the table below (along with maximum plot memory capacity).

Type:	IQ3xcite	IQ3xact	IQ3xcite			
I/O max.:	0	12	16	96	128	
IQ3	brIQs max.	version not available	10,000	30,000	30,000	37,000
	plot memory max. (bytes)		100,000	500,000	500,000	500,000
IQ3/XNC	brIQs max.	45,000	20,000	version not available	45,000	version not available
	plot memory max. (bytes)	500,000	100,000		500,000	

For synchronised plots each plot record requires 5 bytes, so IQ3xcite/128 can have up to 100,000 synchronised plot records. For triggered or periodic plots, each record requires 10 bytes, so IQ3xcite/128 can have up to 50,000 triggered or periodic plot records. Prior to IQ3 v2.1, plots for sensors above sensor 99 could not be viewed by the 963, and that plots for sensors above 256 could only be viewed on web pages; these problems have been fixed with IQ3 v2.1 (and appropriate supervisor upgrade, e.g 963 v3.1).

Each type of module has memory requirement in brIQs as listed below; SET also limits the number of modules as shown in the adjacent table.

**Notes:**

# The actual size in (numbers of brIQs) varies with module type. The largest size is shown here.

\* The time zone brIQ count allows for an average of 20 exceptions.

† The sequence table takes 106 brIQs, the table includes 600 steps.

†† The maximum number of records for a plot is 1000, but maximum total records varies with the type of plots used and the option build of the IQ3 as explained above (see maximum plot memory in table). The maximum number of plots which can occur in 1 s is 100 so there could be 100 off 1 s plots (but no others). This is calculated on the average plots service in 1 s, so a 1 minute plot would contribute a 1/60. For example 90 off 1s, +360 off 1 min would give 90+6= plots/s on average. The periodic and triggered plots must also be counted and it's up to the engineer to make his best estimate.

††† The TCL application consumes brIQs as defined in the IQ3/./XNC data sheet.

†††† The number of NTDs in the IQ3 is only limited by the available brIQs

§ The alarm log can record up to 300 alarms after which the next alarm will overwrite the first alarm (FIFO). They can be viewed on the IQ3 webpages (up to 6 pages of 50 alarms)

§§ The number of Network modules (1 - Ethernet, 2 - IQ Lan, 3 - BACnet), and Option modules (XNC Interface, Battery option card, IQ system Lan Card, Serial card RS232/RS485, XNC Interface, BACnet, XML Web Services) depends on the IQ3 option build.

Category	Module	Size (brIQs)	SET max
Alarm modules	Group	9	500
	Route	9	500
	Destination	14	(8)
	Log§	0	1
Control Modules	Function#	19	500
	IC Comms#	19	250
	Logic#	19	500
	Loop	55	500
	analoge node#	16	510
	digital Byte#		1012
	OSS	34	500
	Sensor type	12	99
	Driver#	57	500
	Digital input#	28	1000
	Knob	13	1000
	Schedule	21	500
	Sequence†	106	1(600 steps)
	Sensor#	76	1000
	Switch	10	1000
	Time Module	38	1
	Time Zone*	566	100
General Modules	Virtual CNC	9	1
	Address	24	1
	I/O module	14	15
	Page	4	500
	XNC Interface†††	130	1
	Non-Trend Device	30	†††
	Network	0	§§
	Option	0	§§
	Program	0	1
	Plots††	12	500
†Display Modules	Directory	13	500
	Display	19	500
	User	12	500

IQ3 has an absolute limit of 4000 modules; the limits imposed by SET prevent this from being exceeded. The IQ3 also limits the number of destination modules to 8 as shown in the table. Network, Program, and Option modules have zero brIQs.

In SET, as the modules are created, a tally is kept of the brIQs used and the amount available to be used; an indication of this can be viewed. If the limit is exceeded, then SET will prohibit the creation of further modules.

It is possible to create modules which are not numerically sequential so module lists can be non-continuous (e.g. L1, L2, L5, L7...).

**FIRMWARE** (continued)

**IC Communications:** The IQ3s may communicate with each other and IQ2 (and IQL) controllers using Inter Controller Communications (peer to peer communications) using IQ System Lan/node addressing.

IQ3/BAC is also able to communicate with BACnet devices using IC Comms; the 'Protocol' parameter specifies either Trend or BACnet protocol. The remote controller in the BACnet IC Comms module specifies an NTD (Non-Trend Device) module which is set with BACnet device's BACnet address information.

The table below specifies the types of IC Comms with which the IQ3 will operate.

IC Comms Type		Configured in IQ2 to IQ3xx	Configured in IQ3xx to IQ2	Configured in IQ3xx to IQ3xx	Configured in IQ3xx to BACnet
Data From	Analogue	*Yes	†Yes	†Yes	†Yes
	Digital Byte	*#Yes	†Yes	†#Yes	No
	Digital Bit	*#Yes	†Yes	†#Yes	†Yes
Data To	Analogue	Yes	Yes	Yes	†Yes
	Digital Byte	Yes	*Yes	*Yes	No
	Digital Bit	Yes	Yes	Yes	†Yes
Global To	Analogue	Yes	Yes	Yes	†Yes
	Digital Byte	Yes	*Yes	*Yes	No
	Digital Bit	Yes	Yes	Yes	†Yes
Visitor Comms (max, min, sum, average)		*Yes	Yes	*Yes	No

\*Only available on IQ3v1.2 or greater firmware.

†Only available on IQ3v2.0 or greater firmware.

#Although the IQ3 will respond to these requests, the digital byte module in the IQ3 cannot be set up by the strategy. However, Digital Bit Data From IC Comms using switch or digital input status as the parameter value being transferred works fine.

Note that IC Comms with IQ1 v3 controllers are similar to those with IQ2 controllers except the IQ3 can only receive messages (i.e. Data To from IQ1), not send them. However, IC Comms with IQ1 v4.1 or greater controllers can be considered to be the same as those with IQ2 controllers.

The receipt of IC Comms by an analog node or digital bit/byte is implemented by creating analogue node or digital byte modules during the strategy creation process on SET.

**Alarms:** The IQ3 will generate Network, General, and Item alarms. Network alarms are generated by the Trend Network nodes, General alarms are generated when the IQ3 detects a problem within its own hardware or program, and Item alarms are generated by the strategy, and are normally due to a faulty plant condition.

**Network alarms** are sent to supervisors or tools connected to the local supervisor port or to the controller's vCNC.

**General and Item alarms** can either be sent in text, coded, or attribute format, and can be sent either to a designated Trend Lan address, to an IP address, as an email, or to a BACnet device (IQ3 BAC only). They are also stored locally in the Alarm Log. Only sensor, digital input, digital driver readback, and plot alarms can be sent to a BACnet device.

For coded alarms the protocol limits the item number to 255 maximum. For text alarms the maximum item label length is 20 characters (although the 963 can be setup to use labels previously learnt).

Sending an Email alarm requires the Email Server Address to be set up in the address module. The Email Server Address can be set up as an IP address, an internet domain name, or a hostname; the internet domain name or host name require a DNS server address or a WINS server address respectively to be set up in the network module so that the name can be resolved.

**Timemaster:** The IQ3 can act as a Timemaster for the Trend system (IQ1s - post 1989, IQ2s, IQ3s, and IQLs). It will maintain time and date synchronisation for all IQ controllers and effect daylight savings from a single source. However, each section of a system separated by auto-dialled links requires its own Timemaster.

The IQ3 does not provide the Timekeeper functionality; this was only required for IQ90's which did not have a battery backed real time clock, and they should be supported by a pre-IQ3 Timekeeper controller on their own Lan.

Note that on a combined system (IQ3s with other IQs) an IQ3 must be the Timemaster.

The Timemaster IQ3 should be fitted with the battery option board which will support it in the case of power failure.

An IQ3 can be set by UTC time (Co-ordinated Universal Time, approximately the same as GMT), and has a UTC Offset parameter to define its time zone difference from UTC time.

The UTC offset and daylight savings details should be set up in the Timemaster so that all other IQs can be synchronised accordingly.

**Language:** The user can specify which language the IQ3 uses for the display of web pages and for transmitted alarms. All the required text is separately stored as a text file in SET and can be translated to form a language file. The required files can be selected for each SET project. English is always available in the controller, but SET enables a default language as well as additional languages to be selected. The appropriate language files will be downloaded to the controller when the strategy is downloaded. In the controller the Address module has a language parameter which will be set by default to the default language, but can be changed to any one of the other available language files or English (e.g. change to English by setting the language parameter to 'english' on the address module webpage). The IQ3 can use languages which require 8 bit code (i.e. special or accented characters) and can also operate with right to left languages (e.g. Chinese, Arabic).

**Plots:** The IQ3 plot modules can plot any connectable module output (analogue or digital). There are three types of plot module: synchronised, triggered, and periodic. Although all three types are BACnet interoperable, only periodic plots can be BACnet compliant. All plot modules can generate a buffer ready alarm when the number of records equals the notification threshold.

## Web Pages

Information from an IQ3 controller can easily be accessed using a Web browser (e.g. Internet Explorer v6.0), over any TCP/IP network (e.g. the company Intranets, or the Internet). All that is required is the IP address or host name of the controller, and a valid user name and password (if users are set up in the controller). Once connection to the controller has been made, it is possible to view and adjust occupation times, view the alarm history, and view/adjust/graph individual module parameters.

Web pages may also be accessed by Mobile smart phones (Windows Mobile 2003 Second Edition), and PDAs (Windows CE4); note that Mobile smart phones and PDAs cannot display graphs and right to left languages

Note that the operating system environment in which Internet Explorer runs must support Java; A Sun Java runtime environment v1.4 or greater can be downloaded from Java.com.

Module parameters may be monitored and changed using web pages but module creation, deletion, and linking can only be done using SET.

The IQ3 is provided with a standard set of web pages which covers all accessible modules (see the example below of the list of knobs, and their current settings).

Web Pages

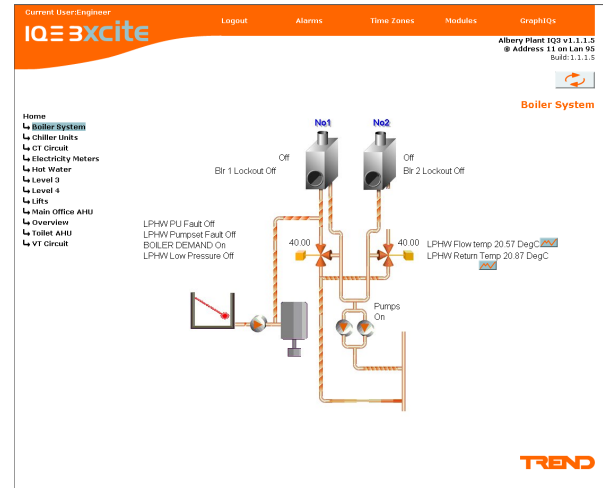

Graphical display pages (GraphIQs) which are configured using IQ3 display and directory modules, can also be accessed (see the example below of a dual boiler system GraphIQ page).

For further details of web pages see the the IQ3 Configuration Reference Manual TA200768, the IQ3 Web User Guide, TC200631, and the IQ3 Graphical Display Pages Editor Manual, TE200629.

FIELD MAINTENANCE

The IQ3 Controller requires virtually no routine maintenance, however it is recommended that if the battery option board is fitted, the battery should be replaced every 5 years, as explained in the IQ3xact or IQ3xcite Installation Instructions. **Other than accessing the auxiliary option board compartment, the unit should not be opened.**

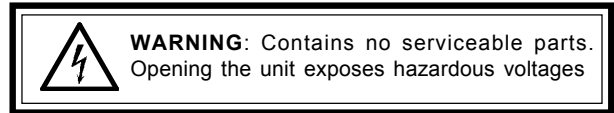

DISPOSAL

COSHH (Control of Substances Hazardous to Health - UK Government Regulations 2002) ASSESSMENT FOR DISPOSAL OF IQ CONTROLLER. The only part affected is the lithium battery (on the battery option board) which must be disposed of in a controlled way.

RECYCLING.

All plastic and metal parts are recyclable. The printed circuit board may be sent to any PCB recovery contractor to recover some of the components for any metals such as gold and silver.

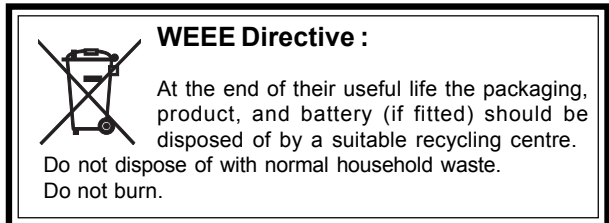

## COMPATIBILITY

- Browsers:** Internet Explorer v6, Mobile smart phones (Windows Mobile 2003 Second Edition), and PDAs (Windows CE4); note that Mobile smart phones and PDAs cannot display graphs and right to left languages  
*Note that IQ3 has not been tested with all devices and Trend cannot guarantee a particular device's compatibility.*  
*Note that the operating system environment in which Internet Explorer runs must support Java; Currently Windows 98, 2000, and ME do support Java, but XP SP1 doesn't. For Windows XP, a Sun Java runtime environment JSE5.0 or greater must be installed (this can be downloaded from Java.com).*
- Supervisors:** 963v3 (for full compatibility), 915MDS >v3, 916, IQView, IQView4
- Utility software:** SET v6.2 for full compatibility (includes IP Tool auxiliary software)
- Displays:** IQView touch screen network display, IQView4 touch screen display, RD-IQ (see requirements p8), SDU-xcite 4 line display (the IQ3 label lengths should be limited to 20 characters for SDU-xcite (< v1.01 firmware), SDU-xcite v1.01 will truncate the label to the first 20 characters.)  
*Note that the NDP is not compatible with IQ3; it will not recognise an IQ3 connected to its network.*
- I/O Modules:** XCITE/IO/8UI, 4UI, 4UI/4AO, 2UI/2AO, 8DO, 4DO, 8AO, 4AO, 16DI, 8DI, 8DI/8TI, 8DO/HOA, 4DO/HOA can connect to IQ3XCITE/96 or /128 only
- Controllers:** IQ3 directly and IQ1, IQ2 by way of 3xtend/EINC L. IQ3/LAN communicates with IQ2, IQ1 directly and IQ3 by way of 3xtend/EINC L
- IC Comms:** IQ3, IQ2 (including IQL, IQ1 (v3 onwards)).
- IQ2 strategies:** These can be imported into SET, converted into IQ3 strategies, and then downloaded into an IQ3.  
 (It is also possible to convert IQ1xx strategies)
- Ethernet Nodes:** Compatible with 3xtend/EINC L. NXIP or EINC must not be used in an automatic IP addressing environment. NXIP cannot be used as cross router master.
- BACnet Devices:** IQ3/BAC only. Being tested as a BACnet Application Specific Controller (B-ASC). Compatibility defined in IQ3 PICs document, (Product Implementation Conformance Statement), TP201002.

The supervisors and tools use different types of communications protocols as shown in the following table:

Function	Comms Level	Software	RJ45 Ethernet	RS232
Set up IP address	Ethernet, MAC	IP Tool (SET application)	Yes	No
Create networks, IC Comms	Ethernet, UDP, TCP, Trend	IQ3, 3xtend/EINC L, NXIP, EINC, IQView	Yes	No
Trend Text Comms	Ethernet, IP, TCP, Trend	963, 915MDS, 916, SET*, IQView, IQView4	Yes	Yes
Strategy Upload/Download	Ethernet, IP, TCP, FTP, Trend	SET	Yes	Yes*
Internet (webpages)	Ethernet, IP, TCP, HTTP, HTML	Browser, 963 (via browser)	Yes	No

\*SET can upload or download the strategy file using the RS232 port, but not the other configuration files (language, backdrops, XNC (for IQ3/XNC only)).

## INSTALLATION

The IQ3 controller is installed on a DIN rail by using the DIN rail clip, inside a cabinet or panel. For /100-240 version, a switch or circuit breaker (240 Vac, 3 A) must be included in the supply to the unit and be in close proximity to it, and must be clearly marked as the disconnecting device for the unit. IQ3.../.../24 controllers are UL rated as 'UL916 listed open energy management equipment'. The procedure involves:

- mount the controller in position
- connect power, do not power up
- connect Ethernet if required
- connect RS232 if required (Supervisor/Tool PC, IQView, IQView4, RD-IQ, or SDU-xcite)
- connect IQ system Lan (IQ3/LAN only)
- terminate the I/O channels, leave unconnected
- connect the I/O bus, if used (IQ3XCITE/96 or /128 only)
- mount and connect any I/O module (IQ3XCITE/96 or /128 only)
- set any I/O module address switches (IQ3XCITE/96 or /128 only)
- perform input channel linking
- insert battery in auxiliary board if appropriate

- power up
- set up IP address parameters (if Ethernet used) using IPTool
- setup Lan number using IPTool,
- setup Device address using address switch (IQ3/LAN) or by IPTool (IQ3s without current loop Lan auxiliary board)
- check Ethernet network, current loop Lan network (IQ3/LAN only)
- configure the strategy and I/O modules used (using SET)
- test strategy by using Controller Simulation Mode in SET
- download strategy file and other configuration files
- check BACnet communications using SET (IQ3/BAC only)
- connect inputs and check operation
- connect outputs and check operation
- check web pages using a browser

This installation procedures are covered as follows: IQ3xact Installation Instructions, TG200766; IQ3xcite Installation Instructions, TG200626; XCITE Standard I/O Modules Installation Instructions, TG200627; XCITE/IC I/O Bus Interconnector Installation Instructions, TG200644; XCITE/TERM I/O Bus Terminator Installation Instructions, TG200645; XCITE/BBC IQ3 Battery Option Board Installation Instructions, TG200627; IQ3.../.../XNC/... Installation Instructions TG200911 (see also IQ3.../.../XNC/... data sheet TA200912), IQ3.../.../LAN/... Installation Instructions TG200916, IQ3 Web Services Upgrade Information Sheet TP201077.

**WARNING** If the unit is used in a manner other than that specified in the installation instructions, the protection provided by the unit may be impaired.

## CONNECTIONS

### I/O MODULES (IQ3XCITE/96/..., /128/.. only)

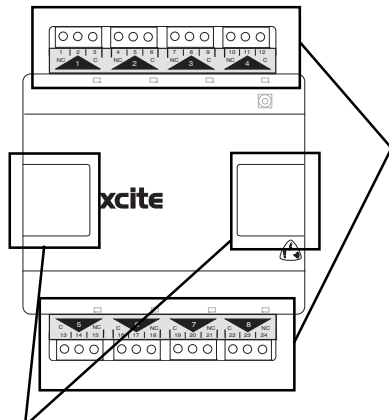

### Inputs and Outputs

The Universal input and Analogue output channel wiring is the same as shown for the main controller overleaf.

The Relay output connections are as follows:

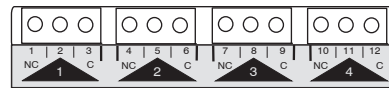
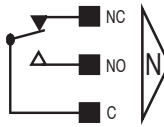

The Digital input (/16DI, /8DI) connections are as follows (details are on page 11):

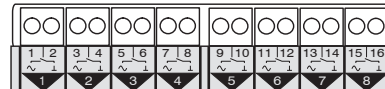

Cable size 0.14 to 2.5 mm<sup>2</sup>, 24 to 14 AWG (for USA/UL use 22 to 14 AWG) - Cu only

### I/O Bus

Must use rules shown on page 9

Connect IQ3xcite to I/O module. Use rigid interconnector for adjacent module (XCITE/IC, supplied with I/O module).

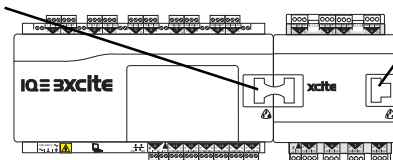

Terminate at far end using XCITE/TERM (supplied with controller)

Non-adjacent modules can be connected via connectors, and earthed locally. No spurs.

Use Belden 3084A cable

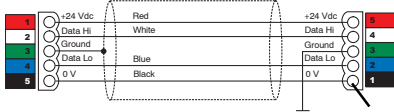

XCITE/PCON/50 cable facilitates connection of external power supply for adjacent modules.



Connect additional 24 Vdc PSU (with isolated output) if needed. Note that an external PSU must comply with relevant EMC and safety standards.

XCITE/PCON/1000 (1 m, 1 yd 3" cable) can be used for non adjacent modules

CONNECTIONS (continued)

MAIN CONTROLLER

**Universal Inputs** Cable size 0.14 to 2.5 mm<sup>2</sup> cross section area, 24 to 14 AWG for USA/UL use 22 to 14 AWG) - Cu only

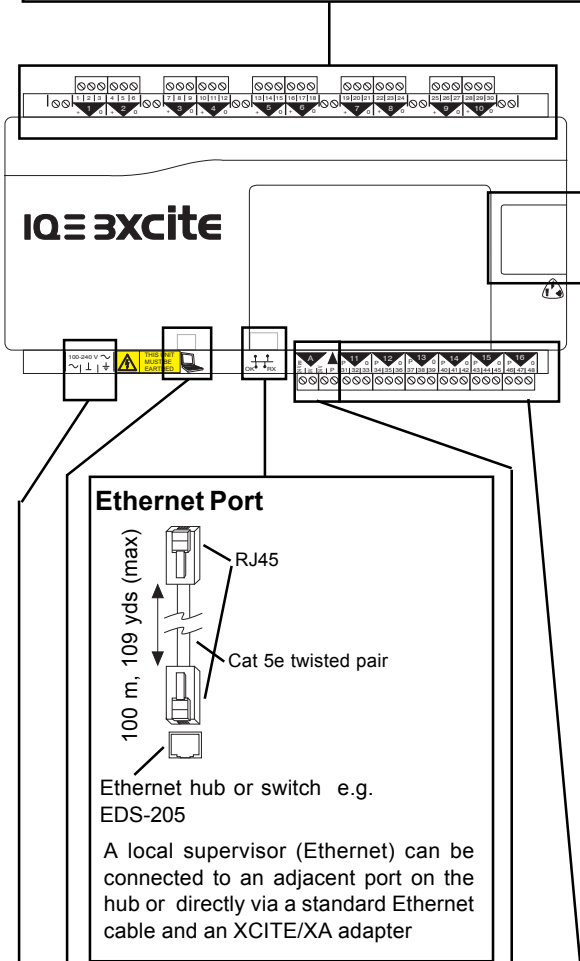

**Ethernet Port**

RJ45

100 m, 109 yds (max)

Cat 5e twisted pair

Ethernet hub or switch e.g. EDS-205

A local supervisor (Ethernet) can be connected to an adjacent port on the hub or directly via a standard Ethernet cable and an XCITE/XA adapter

**Local Supervisor Port**

RJ11 (FCC68)

RJ11 to 9 way 'D type' female cable CABLE/EJ101442

PC (e.g. 916, 963, SET)

CABLE/EJ105650 connects to IQView

RJ11 to RJ11

RD/SDU-IQ2COMMSCABLE/nM (n=3, 3m; n=10, 10m) connects to RD-IQ or SDU-xcite

**I/O Bus (IQ3XCITE/96/..., /128/.. only)**

**Must use rules shown on page 9**

Connect IQ3xcite to I/O module. Use rigid interconnector for adjacent module (XCITE/IC, supplied with I/O module).

Terminate at far end using XCITE/TERM (supplied with controller)

Non-adjacent modules can be connected via connectors, and earthed locally. No spurs.

Use Belden 3084A cable XCITE/CC/10 pack 10 (order separately)

Connect additional 24 Vdc PSU (with isolated output) if needed.

*Note that external power supply must comply with relevant EMC and safety standards*

XCITE/PCON/50 cable facilitates connection of external power supply for adjacent modules.

XCITE/PCON/1000 (1 m, 1yd 3" cable) can be used for non adjacent modules

**Analogue Outputs** Cable size 0.14 to 2.5 mm<sup>2</sup> cross section area, 24 to 14 AWG (for USA/UL use 22 to 14 AWG) - Cu only

e.g. IQ3, SRMV

~~SRMAC~~ Analogue outputs are not suitable for ac relays

**Auxiliary Supply Out**

24 Vdc at 150 mA max.

**Supply (option)**

/100-240 46 VA max. 100 to 240 Vac 50/60 Hz

/24 40 VA max. 24-60 V ~ 24 V ~ 24 Vac 50/60 Hz 24 to 60 Vdc (36 Vdc maximum for /UL versions)

**Power Bus**

Either Internal power supply Or External power supply

External link (not supplied)

Separate 24 Vac/Vdc power supply. Supply be dedicated to I/O channel use and must comply with relevant EMC and safety standards

**CONNECTIONS** (continued)

IQ3../LAN only

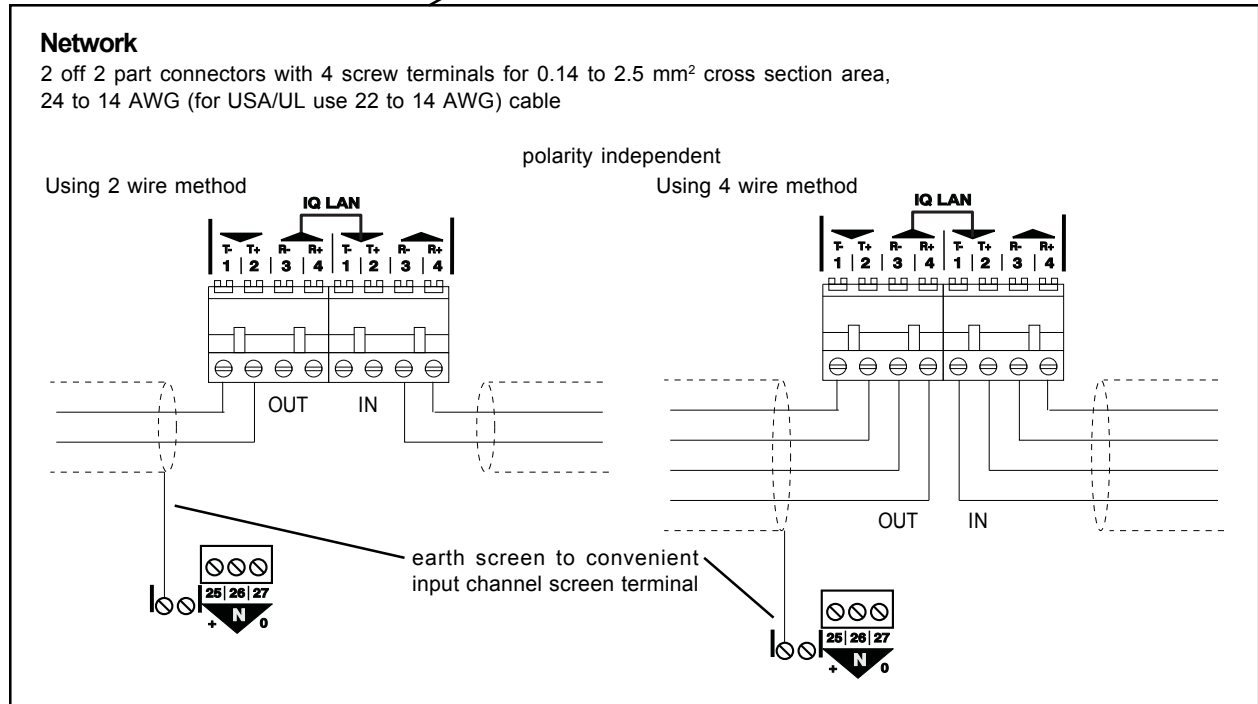
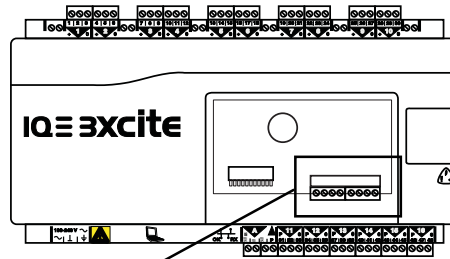

**ORDER CODES**

**Controllers**

IQ3[TYPE]/[XNC]/[AUX BD]/[COUNTRY]/[BAC]/[POWER]

<b>[TYPE]</b>	XCITE/00	zero I/O points, non expandable via I/O bus. Supplied with bus terminator.
	XACT/12	12 I/O points, 6 universal inputs, 6 analogue voltage outputs, non expandable via I/O bus.
	XCITE/16	16 I/O points, 10 universal inputs, 6 analogue voltage outputs, non expandable via I/O bus. Supplied with bus terminator.
	XCITE/96	16 I/O points, 10 universal inputs, 6 analogue outputs expandable up to 96 points (i.e. 80 additional I/O channels) by addition of I/O modules to I/O bus. Supplied with I/O bus terminator.
	XCITE/128	16 I/O points, 10 universal inputs, 6 analogue outputs expandable up to 128 points (i.e. 112 additional I/O channels) by addition of I/O modules to I/O bus. Supplied with I/O bus terminator.
<b>[XNC]</b>	blank	no XNC capability
	XNC	XNC capability included. Enables interfacing with 3rd party systems. See IQ3/XNC data sheet
<b>[AUX BD]</b>	blank	No auxiliary board fitted
	LAN	IQ system current loop Lan interface fitted
	SER	Second serial port interface fitted (RS232 or RS422/485). See IQ3/XNC data sheet
<b>[COUNTRY]</b>	blank	Worldwide except US
	USA/UL	For sale in US, UL rated
<b>[BAC]</b>	blank	No BACnet protocol capability
	BAC	BACnet protocol capability included
<b>[POWER]</b>	100-240	100 to 240 Vac supply
	24	24 Vac or 24 to 60 Vdc supply (36 Vdc maximum for UL versions)

**Controllers** (continued)**Available codes:**

IQ3XCITE/00/XNC/LAN/100-240:  
 IQ3XCITE/00/XNC/SER/100-240:  
 IQ3XCITE/00/XNC/100-240:

IQ3XCITE/00/XNC/LAN/24:  
 IQ3XCITE/00/XNC/SER/24:  
 IQ3XCITE/00/XNC/24:

IQ3XACT/12/100-240:  
 IQ3XACT/12/LAN/100-240:  
 IQ3XACT/12/XNC/LAN/100-240:  
 IQ3XACT/12/XNC/SER/100-240:  
 IQ3XACT/12/XNC/100-240:

IQ3XACT/12/24:  
 IQ3XACT/12/LAN/24:  
 IQ3XACT/12/XNC/LAN/24:  
 IQ3XACT/12/XNC/SER/24:  
 IQ3XACT/12/XNC/24:

IQ3XCITE/16/100-240:  
 IQ3XCITE/16/LAN/100-240:

**BACnet versions**

IQ3XCITE/00/XNC/LAN/BAC/100-240:  
 IQ3XCITE/00/XNC/SER/BAC/100-240:  
 IQ3XCITE/00/XNC/BAC/100-240:

IQ3XCITE/00/XNC/LAN/BAC/24:  
 IQ3XCITE/00/XNC/SER/BAC/24:  
 IQ3XCITE/00/XNC/BAC/24:

IQ3XACT/12/BAC/100-240:  
 IQ3XACT/12/LAN/BAC/100-240:  
 IQ3XACT/12/XNC/LAN/BAC/100-240:  
 IQ3XACT/12/XNC/SER/BAC/100-240:  
 IQ3XACT/12/XNC/BAC/100-240:

IQ3XACT/12/BAC/24:  
 IQ3XACT/12/LAN/BAC/24:  
 IQ3XACT/12/XNC/LAN/BAC/24:  
 IQ3XACT/12/XNC/SER/BAC/24:  
 IQ3XACT/12/XNC/BAC/24:

IQ3XCITE/16/BAC/100-240:  
 IQ3XCITE/16/LAN/BAC/100-240:

IQ3XCITE/16/24:  
 IQ3XCITE/16/LAN/24:

IQ3XCITE/96/100-240:  
 IQ3XCITE/96/LAN/100-240:  
 IQ3XCITE/96/XNC/LAN/100-240:  
 IQ3XCITE/96/XNC/SER/100-240:  
 IQ3XCITE/96/XNC/100-240:

IQ3XCITE/96/24:  
 IQ3XCITE/96/LAN/24:  
 IQ3XCITE/96/XNC/LAN/24:  
 IQ3XCITE/96/XNC/SER/24:  
 IQ3XCITE/96/XNC/24:

IQ3XCITE/128/100-240:  
 IQ3XCITE/128/LAN/100-240:

IQ3XCITE/128/24:  
 IQ3XCITE/128/LAN/24:

IQ3XCITE/16/BAC/24:  
 IQ3XCITE/16/LAN/BAC/24:

IQ3XCITE/96/BAC/100-240:  
 IQ3XCITE/96/LAN/BAC/100-240:  
 IQ3XCITE/96/XNC/LAN/BAC/100-240:  
 IQ3XCITE/96/XNC/SER/BAC/100-240:  
 IQ3XCITE/96/XNC/BAC/100-240:

IQ3XCITE/96/BAC/24:  
 IQ3XCITE/96/LAN/BAC/24:  
 IQ3XCITE/96/XNC/LAN/BAC/24:  
 IQ3XCITE/96/XNC/SER/BAC/24:  
 IQ3XCITE/96/XNC/BAC/24:

IQ3XCITE/128/BAC/100-240:  
 IQ3XCITE/128/LAN/BAC/100-240:

IQ3XCITE/128/BAC/24:  
 IQ3XCITE/128/LAN/BAC/24:

The versions available in the USA are restricted to /BAC/24 versions (BACnet, 24 V power) and are identified by adding /USA/ UL/ before BAC/24 e.g.:

**IQ3XACT/12/USA/UL/BAC/24:** Web enabled controller with 6 Universal Inputs, and 6 Analogue Voltage Outputs, non expandable by the I/O bus. 24 Vac or 24 to 36 Vdc input power supply. BACnet option. For USA, UL rated.

**XML Web Services Upgrades**

**IQ3XACT/XML/UP** :XML Web Services upgrade for IQ3xact  
**IQ3XCITE/XML/UP** :XML Web Services upgrade for IQ3xcite

**I/O Modules**

**XCITE/IO/8UI** :8 channel universal input I/O module. Supplied with rigid interconnector.  
**XCITE/IO/4UI** :4 channel universal input I/O module. Supplied with rigid interconnector.  
**XCITE/IO/4UI/4AO** :4 channel universal input and 4 channel analogue voltage output I/O module. Supplied with rigid interconnector.  
**XCITE/IO/2UI/2AO** :2 channel universal input and 2 channel analogue voltage output I/O module. Supplied with rigid interconnector.  
**XCITE/IO/8DO** :8 channel relay output I/O module. Supplied with rigid interconnector.  
**XCITE/IO/4DO** :4 channel relay output I/O module. Supplied with rigid interconnector.  
**XCITE/IO/8AO** :8 channel analogue voltage output I/O module. Supplied with rigid interconnector.  
**XCITE/IO/4AO** :4 channel analogue voltage output I/O module. Supplied with rigid interconnector.  
**XCITE/IO/16DI** :16 channel digital input I/O module. Supplied with rigid interconnector.  
**XCITE/IO/8DI** :8 channel digital input output I/O module. Supplied with rigid interconnector.  
**XCITE/IO/8DI/8TI** :8 channel digital input and 8 channel thermistor input I/O module. Supplied with rigid interconnector.  
**XCITE/IO/8DO/HOA** :8 channel relay output with Hand/Off/Auto switch I/O module. Supplied with rigid interconnector.  
**XCITE/IO/4DO/HOA** :4 channel relay output with Hand/Off/Auto switch I/O module. Supplied with rigid interconnector.

The USA versions of I/O modules are identified by placing /USA/UL/ before the I/O module type code in the order codes e.g.:  
**XCITE/IO/USA/UL/8UI:** 8 channel universal input I/O module. Supplied with rigid interconnector. UL rated.

## Controller Accessories

<b>XCITE/BBC</b>	:Battery option board increases protection time of clock (in case of input power supply failure) to several years (e.g. for Timemaster).
<b>XCITE/IC/5</b>	:Pack of 5 rigid I/O bus interconnectors for adjacent I/O modules (spare)
<b>XCITE/TERM/5</b>	:Pack of 5 I/O bus terminators (spare)
<b>XCITE/CC/10</b>	:Pack of 10 I/O bus connectors with screw terminals to facilitate wired connection (one required each end).
<b>XCITE/PCON/50</b>	:I/O bus interconnector (4 wide) for adjacent I/O modules to facilitate connection of external bus power supply
<b>XCITE/PCON/1000</b>	:1 m, 1 yd 3" I/O bus connection cable (4 wide) between I/O modules to facilitate connection of external bus power supply
<b>CABLE/EJ101442</b>	:Adaptor cable to connect PC to local supervisor port
<b>XCITE/XA/5</b>	:Pack of 5 Ethernet connector adaptors for direct connection of a PC to the IQ3 using a standard Ethernet cable
<b>PSR/230/24-1.3</b>	:1.3 A DIN rail mounted 24 Vdc power supply (isolated output) suitable for supplying I/O modules (not USA).
<b>PSR/230/24-2.5</b>	:2.5 A DIN rail mounted 24 Vdc power supply (isolated output) suitable for supplying I/O modules (not USA).

## Peripherals

<b>IQView Mono/SM/24</b>	:Surface mounting touch screen display with 'Mono'* application including RJ11 to RJ11 RS232 cable (not USA).
<b>IQView Mono/SM/USA/UL/24</b>	:as per UK version above plus UL rated (for USA).
<b>IQView/SM/24</b>	:Surface mounting touch screen display with standard* application (not USA).
<b>IQView/SM/USA/UL24</b>	:as per UK version above plus UL rated (for USA).
<b>IQView Mono/RPM/24</b>	:Rear panel mounting touch screen display with 'Mono'* application including RJ11 to RJ11 RS232 cable (not USA).
<b>IQView Mono/RPM/USA/UL/24</b>	:as per UK version above plus UL rated (for USA).
<b>IQView/RPM/UK/24</b>	:Rear panel mounting touch screen display with standard* application (not USA).
<b>IQView/RPM/USA/UL/24</b>	:as per UK version above plus UL rated (for USA).

\*Note that IQView Mono/ has an RS232 communications interface; IQView/ (standard) also has current loop Lan and Ethernet interfaces

<b>SDU-XCITE</b>	:Smart Display unit for IQ3 within UK label set. Wall mounting unit with 2x40 electroluminescent display allowing viewing and adjustment of control parameters and times (not USA).
<b>SDU-XCITE/WSA/USA</b>	:as per UK version plus wall sensor adaptor plate for mounting on USA wallbox (for USA).
<b>RD-IQ/K</b>	:Wall mounting Room Display with local thermistor temperature sensor and setpoint control (not USA).
<b>RD-IQ/K/WSA/USA</b>	:as per UK version plus wall sensor adaptor plate for mounting on USA wallbox (for USA).
<b>RD-IQ/KOS</b>	:Wall mounting Room Display with local thermistor temperature sensor, setpoint control, occupation override, and occupation status display (not USA).
<b>RD-IQ/KOS/WSA/USA</b>	:as per UK version plus wall sensor adaptor plate for mounting on USA wallbox (not USA).
<b>RD-IQ/KOSF</b>	:Wall mounting Room Display with local thermistor temperature sensor, setpoint control, occupation override, occupation status display, and fan speed control (not USA).
<b>RD-IQ/KOSF/WSA/USA</b>	:as per UK version plus wall sensor adaptor plate for mounting on USA wallbox (for USA).
<b>RD/SDU-IQ2COMMSCABLE/3M</b>	:3 m, 3 yds 10" cable to connect RD-IQ or SDU-xcite to IQ3
<b>RD/SDU-IQ2COMMSCABLE/10M</b>	:10 m, 11 yds cable to connect RD-IQ or SDU-xcite to IQ3
<b>SDU DOWNLOAD ADAPTOR</b>	:(EJ105174) RJ11 socket to RJ11 plug, download adaptor cable for use with CABLE/EJ10442 for SDU-xcite configuration by PC running SDU Tool (an applet running in SET available from your supplier's website and protected by licence)

## Accessories

<b>TP/1/1/22/HF/200</b>	:200m of screened single twisted pair 0.34mm <sup>2</sup> (22AWG) (Belden equivalent 8761NH), for use on current loop Lan (IQ3/LAN version), input/output channel wiring (not USA).
<b>TP/2/2/22/HF/200</b>	:200m of screened twin twisted pair 0.34mm <sup>2</sup> (22AWG) (Belden equivalent 8723NH), for use on current loop Lan (IQ3/LAN version) (not USA).
<b>EDS-205</b>	:Unmanaged Ethernet switch with 5 off 10/100BaseT(X) ports (not USA).
<b>EDS-305-M-SC</b>	:Unmanaged Ethernet switch with 4 off 10/100BaseT(X) ports, 1 multimode100BaseFX (fibre optic) port (not USA).
<b>IMC-101-M-SC</b>	:1 channel 10/100BaseT(X) to multimode 100BaseFX (fibre optic) converter (not USA).

**SPECIFICATIONS**

**MAIN CONTROLLER**

**Electrical**

CPU :MCF5272  
 CPU speed :66 MHz  
 Cycle time :sequence table 1s  
 Memory :16 Mbyte SDRAM, and 8 Mbyte Flash.  
 IQ3xcite/128 :37000 briQs (module capacity see p13)  
 IQ3xact :6000 briQs (module capacity see p13)  
 Input power supply voltage  
 /100-240 :100 to 240 Vac ±10% 50/60 Hz  
 /24 :24 to 60 Vdc ±10% (36 Vdc maximum for /UL versions), 24 Vac ±15% 50/60 Hz  
 Input power supply consumption  
 /100-240 :6 VA minimum  
 IQ3XCITE/000 :15 VA maximum  
 IQ3XACT/012 :28 VA maximum  
 IQ3XCITE/016 :39 VA maximum  
 IQ3XCITE/096, /128 :56 VA maximum  
 /24 :5 VA minimum  
 IQ3XCITE/000 :11 VA maximum  
 IQ3XACT/012 :25 VA maximum  
 IQ3XCITE/016 :28 VA maximum  
 IQ3XCITE/096, /128 :40 VA maximum  
 Input Supply Leakage :Leakage current at 230 Vac, 50 Hz is less than 0.3 mA.  
 24 Vdc combined supply :24 Vdc ±10%, 700 mA maximum (typical) to supply 24 Vdc auxiliary supply terminals, I/O bus, RS232, the I/O channels (see page 6). Output derated to 550 mA for input power supply <200 Vac.  
 24 Vdc auxiliary supply: Part of combined supply, 20 to 24 Vdc limited to 150 mA supplied to RS232, 24 V auxiliary output supply, and may be linked to output power bus.  
 Fusing :No replaceable fuses required.  
 24 Vdc combined supply :protected by a self resetting solid state circuit breaker.  
 RS232, 24 V :part of the combined supply to RS232, 24 V auxiliary output supply (and output power bus, if linked) is protected by 150 mA current limit.  
 Power bus :protected by a 1.6 A multifuse.  
 Power supply :protected against catastrophic failure by a non-replaceable fuse.  
 Analogue output :circuitry is protected against the wrong connection of a non-isolated external supply by a non-replaceable fuse.  
 Power failure protection :All strategy and data in nonvolatile memory. Supercap maintains real time clock for up to 6 days (typical). Option to fit a battery board to maintain clock for up to several years in the case of input supply failure.  
 Battery option :XCITE/BBC, battery option board includes CR2032 3V lithium button cell. Feature also included on IQ3.../LAN or IQ3.../SER versions but battery not provided.  
 Clock accuracy :30 s per month (typical).  
 4-line display panel :SDU-xcite to local supervisor port  
 Ethernet :main bus, 10 BASE-T (IEEE 802.3). Supports TCP/IP, FTP  
 Supervisor Port  
 Transmission :RS232, EIA/TIA/232E, V28 supports IQ System comms  
 Distance :15 m, 16 yds  
 Baud rate :9k6.  
 Address :Selectable by software, 116 nodes addressable (1, 4 to 119 excluding 2,3,10) set to be unique on Lan.

IQ Current Loop Lan Transmission : (IQ3.../LAN only)  
 :20 mA two wire current loop, opto-isolated, polarity independent receiver, balanced transmitter  
 Distance :Dependent on cable type, see table below:

Cable	9k6 baud	19k2 baud	No. of Wires
Belden 9182	1000 m (1090 yds)	700 m (765 yds)	2
Belden 9207	1000 m (1090 yds)	500 m (545 yds)	2
Trend TP/1/1/22/HF/200 (Belden 8761)	700 m (765 yds)	350 m (380 yds)	2
Trend TP/2/2/22/HF/200 (Belden 8723)	500 m (545 yds)	250 m (270 yds)	4

Baud rate :Selectable by board switches 9k6, 19k2 - set to be same as other nodes on Lan.  
 Address :The IQ3 address on Lan is set by board switches. Set to be unique on network; 116 nodes addressable (1 to 119 excluding addresses 2,3, and 10) Virtual CNC address, supervisor port address to be configured in strategy.  
 Serial Port 2 : (IQ3.../SER only)  
 RS232 or RS422/485 selectable by software. See IQ3.../XNC data sheet for details  
 I/O bus : (not fitted on IQ3xact or IQ3XCITE/00) maximum length 30 m, 33 yds, 15 additional nodes maximum, 96 points maximum. Signalling rate 125 kbits/s. Cable Belden 3084A.  
**Inputs/Outputs**  
 IQ3XCITE/00 :zero I/O  
 IQ3XACT :6 universal inputs, 6 voltage outputs  
 IQ3XCITE/16 :10 universal inputs, 6 voltage outputs  
 IQ3XCITE/96 :10 universal inputs, 6 voltage outputs expandable by adding I/O modules to 96 points maximum  
 IQ3XCITE/128 :10 universal inputs, 6 voltage outputs expandable by adding I/O modules to 128 points maximum  
 Signal Cable :Universal inputs, and analogue voltage outputs; TP/1/1/22/HF/200 recommended (Belden 8761)  
 Measurement Category :Universal inputs and analogue voltage outputs are Measurement CAT I (EN61616:2001). They must be separated from 230 Vac input power supply by double or reinforced insulation.  
**Universal inputs**  
 Analogue voltage (V) :12 bit resolution. Minimum 60 dB series mode rejection at input power supply frequency. 0 to 10 V, input resistance 200 kΩ, accuracy 50 mV equivalent to ±0.5% of span.  
 Analogue current (I) :12 bit resolution (4096 steps - effective). Minimum 60 dB series mode rejection at input power supply frequency. 0 to 20 mA, input resistance 240 Ω, accuracy 0.5% of span (i.e. 100 μA). Loop powered input supply is 20 to 36 Vdc.  
 Thermistor (T) :12 bit resolution. Minimum 60 dB series mode rejection at input power supply frequency. Thermistor bridge resistor 10 kΩ 0.1%, accuracy 0.5% of span. Bridge supply 5 V.

**SPECIFICATIONS** (CONTINUED)

Digital (D)	:volt free contact, open collector (or drain), or logic input. Count rate 30 Hz (minimum pulse width of 16.6ms). 5V supply. Status LED per channel. Volt free contact input: Wetting current = 3 mA nominal. (ON = closed contact.) Open collector (or drain) input: Must be able to sink 3 mA. Must be earthed (grounded) to same earth (ground) as IQ3. Polarity dependent. (ON=transistor/FET conducts.) Logic input: Logic high level 5 to 50 V. Logic low level must be able to sink 3 mA (ON = logic low.)
<b>Analogue voltage outputs</b>	:Channels 11 to 16. 11 bit resolution. 0 to 10 V with 20 mA current limit, accuracy $\pm 0.5\%$ of span.
<b>Indicators</b>	
Inputs	:(yellow) Indicates status, only for digital inputs (ON= contact closed) Analogue Outputs :(yellow) Light intensity increases with output voltage
⚡ (power)	:(green) ON when input power supply is connected. Flashing at 1 second intervals indicates power supply fault.
! (watchdog)	:(red) ON if controller has a software fault
🔊 (I/O bus)	:(red, not fitted on IQ3xact) On if there is an I/O bus fault.
OK	:(green) Normally called LINK on Ethernet systems. ON indicates a good Ethernet connection.
RX	:(yellow) Flashes when packet of data is being received across the Ethernet.
<b>IQ Current Loop Lan Indicators</b> :IQ3../.../LAN only	
TX	:(yellow) ON if current is flowing from the current loop network transmitter
RX	:(yellow) ON if current is entering the current loop network receiver
OK	:(green) ON if IQ3 successfully communicating over current loop network.
<b>Mechanical</b>	
Dimensions	
Controller	:263 mm (10.35") x 150 mm (5.91") max. x 46 mm (1.81") IQ3../.../LAN, or IQ3../.../SER 263 mm (10.35") x 150 mm (5.91") max. x 56 mm (2.2")
Material	:Polycarbonate
Weight	
Controller	:702 gm (1.5 lb)
Connectors	
Input power supply	:2 part connector with 3 rising cage clamp screw terminals for 0.5 to 2.5 mm <sup>2</sup> cross section area (14 to 20 AWG) cable.
I/O	:2 part connectors with rising cage clamp screw terminals for 0.14 to 2.5 mm <sup>2</sup> cross section area, 24 to 14 AWG (for USA/UL use 22 to 14 AWG) cable. Use copper cable only.
Screens	:Single part connectors with rising cage clamp screw terminals for 0.14 to 2.5 mm <sup>2</sup> cross section area, 24 to 14 AWG (for USA/UL use 22 to 14 AWG) cable. Use copper cable only.
Supervisor port	:RJ11 (FCC68), for IQ System utility software, supervisor, RD-IQ, SDU-xcite, or IQView. Connected by adaptor cable (see order codes section). Can supply signal and power.
Ethernet	:RJ45 connector, unshielded or shielded twisted pair (UTP or FTP) cable 10 Mbps, 100 m (109 yds), 10 BASE-T. Cable and connectors are available (see product codes). Connect local supervisor (Ethernet) by way of adjacent hub or directly using standard Ethernet cable and XCITE/XA adaptor

I/O bus	:(not fitted on IQ3xact or IQ3XCITE/00) 5 wide connector. For expandable controller only, connect with special rigid interconnector (XCITE/IC, supplied with I/O Module) to adjacent module, or use connector with screw terminals (XCITE/CC/10 - pack of 10) and wire in Belden 3084A or equivalent. Last connection requires termination (XCITE/TERM supplied with IQ3xcite controller only). Special 4 wide cables available to facilitate connection of additional I/O bus power supply; XCITE/PCON/50 for adjacent I/O module, XCITE/PCON/1000 for cable connection to I/O module up to 1 m, 1 yd 3". The maximum current that can be passed through the I/O module using the 24 Vdc and 0 V terminals from one module to the next is 2.5 A.
---------	---------------------------------------------------------------------------------------------------------------------------------------------------------------------------------------------------------------------------------------------------------------------------------------------------------------------------------------------------------------------------------------------------------------------------------------------------------------------------------------------------------------------------------------------------------------------------------------------------------------------------------------------------------------------------------------------------------------------------------------------------

**Environmental**



EMC	
Emissions	:EN61000-6-3:2001
Immunity	:EN61000-6-2:2001
Safety	
EU	:EN61010-1:2001 (Installation Category III - fixed installations)
USA/Canada	:/24 only. UL rated as 'UL916 listed open energy management equipment'
Canada	:CSA22.2 No. 205-M1983 - Signal Equipment
Protection	:IP20, NEMA1
Ambient limits	
storage	:-10 °C (14 °F) to +50 °C (122 °F)
operating	:0 °C (32 °F) to 45 °C (113 °F)
humidity	:0 to 90 %RH non-condensing
<b>Version</b>	This document covers:
Firmware	:v2.2
Boards	
IQ3	:/100-240 Baseboard AM104979 Issue 3 /24 Baseboard AM105463 Issue 3 CPU board AM104700 Issue 1 /LAN auxiliary board AM105147 issue 1
I/O bus	:XCITE/IC AM105225 Issue 1 XCITE/TERM AM105226 Issue 1

**I/O MODULES** (for use with IQ3XCITE/96 only)**Electrical**

CPU	:microprocessor PIC 18F458
Input power supply voltage	:24 Vdc $\pm 15\%$
Input power supply consumption	:Maximum: 8DO=100 mA, 4DO=60 mA, 8UI=180 mA, 4UI=100 mA, 16DI=36 mA, 8DI=28 mA, 8DI/8TI=30 mA, 4UI/4AO=180 mA (+Aux supply 150 mA), 2UI/2AO=100 mA (+Aux supply 150 mA), 8AO=180 mA (+Aux supply 300 mA), 4AO=100 mA (+Aux supply 150 mA), 8DO/HOA=100mA, 4DO/HOA=60 mA, - see page 10 for calculation.
Auxiliary output supply	:(AO only) 18 to 24 Vdc, limited to 150 mA per bank of four AO.
Fusing	:no replaceable fuses required. Auxiliary output supply :protected by a 150 mA current limit. Analogue output bus :protected by a 1.6 A multifuse. Analogue output circuitry :protected against the wrong connection of a non-isolated external supply by a non-replaceable fuse.
I/O bus	:maximum length 30 m (33 yds), 15 additional nodes maximum, 96 points maximum. Signalling rate 125 kbits/s. Cable Belden 3084A (see rules page 9).

**SPECIFICATIONS** (continued)

<b>Inputs/outputs</b>	:selectable from range of 8UI, 4UI, 4UI/4VO, 2UI/2VO, 8DO, 4DO, 16DI, 8DI, 8DI/8TI, 8AO, 4AO, 8DO/HOA, or 4DO/HOA.
Key:	UI Universal input DI Digital input TI Thermistor input VO Analogue voltage output RO Relay output
Signal Cable	:Universal inputs, and analogue voltage outputs; TP/1/1/22/HF/200 recommended (Belden 8761)
<b>Universal input</b>	:as for main controller
<b>Analogue voltage output</b>	:as for main controller except 10 bit resolution
<b>Relay output</b>	:Relay outputs with LED (yellow) status indication (on = energised) per channel. Single pole changeover relays. Outputs rated at 5 A maximum for 240 Vac single phase only (use same phase throughout) inductive, ( $\cos\phi \geq 0.4$ ), or resistive load, 30 Vdc (resistive load). Reduce to 2 A for 24 Vdc (inductive load, $T \leq 30$ ms). For /USA only, UL rating applies up to 240 Vac (120 VA) maximum. Arc suppression recommended, (see Relay Output Arc Suppression Installation Instructions TG200208).
<b>Relay output with Hand/Off/Auto</b>	:As for relay output above plus single 3 way switch per channel to select either manual override ON (Hand), manual override off (Off) or automatic control (Auto) and additional LED (red) per channel to indicate manual override condition.
Thermistor input	:12 bit resolution. Minimum 60 dB series mode rejection at input power supply frequency. Thermistor bridge resistor 10 k $\Omega$ 0.1%, accuracy 0.5% of span. Bridge supply 5 V.
<b>Digital input</b>	:voltage free contact, 24 Vac, open collector (or drain) or logic input. Count rate 30 Hz (minimum pulse width of 16.6 ms). 5 V supply. Status LED per channel. Voltage free contact input: Wetting current = 3 mA nominal. (ON = closed contact.) 24 Vac input: 24 Vac $\pm 20\%$ . Must be floating or earthed (grounded) to same earth (ground) as IQ3, polarity dependent. (ON = load powered.) Open collector (or Drain) input: Must be able to sink 3 mA. Must be earthed (grounded) to same earth (ground) as IQ3, Polarity dependent. (ON = transistor/FET conducts.) Logic input: Logic high level 5 to 50 V. Logic low level must be able to sink 3 mA. (ON = logic low.)
<b>Indicators</b>	
Inputs	:(yellow) Indicates status, only for digital inputs (ON= contact closed or equivalent)
Analogue Outputs	:(yellow) Light intensity increases with output voltage.

Relay Outputs	:(yellow). Indicates relay status (ON = relay energised)
Manual override	:(red). Indicates the relay output channel is manually overridden. /8DO/HOA, /4DO/HOA only.
Excess Aux. Current	:(red) Indicates maximum auxiliary current exceeded. /8AO, /4AO only
Input Polarity Error	:(red) Indicates 24 Vac input grounding error (ON=error). /16DI, /8DI only.
 (power)	:(green) ON when supply is connected
 (watchdog)	:(red) ON if module has a software fault
 (I/O bus)	:(red) On if there is an I/O bus fault. Flashes at 1 second intervals if the I/O module has not been in receipt of any valid comms for 30 secs (outputs will be switched off). Flashes faster if an address clash on I/O bus, or the address has been set to zero (I/O module disabled).

**Mechanical**

Dimensions	
I/O Module	:130 mm (5.12") x 150 mm (5.91") max. x 46 mm (1.8")
Material	:Polycarbonate
Protection	:IP20, NEMA1
Weight	
I/O Module	:332 gm, 0.73 lb (approx.)
Connectors	
Power in	:2 part connector with 3 rising cage clamp screw terminals for 0.5 to 2.5 mm <sup>2</sup> cross section area (14 to 20 AWG) cable.
I/O	:2 part connectors with rising cage clamp screw terminals for 0.14 to 2.5 mm <sup>2</sup> cross section area, 24 to 14 AWG (for USA/UL use 22 to 14 AWG) cable. Use copper cable only.
Screens	:Single part connectors with rising cage clamp screw terminals for 0.14 to 2.5 mm <sup>2</sup> cross section area, 24 to 14 AWG (for USA/UL use 22 to 14 AWG) cable.
I/O bus	:5 wide connector. Connect with special rigid interconnector (XCITE/IC supplied with I/O Module) to adjacent module or controller, or use connector with screw terminals (XCITE/CC/10 - pack of 10) and wire in Belden 3084A or equivalent. Last connection requires termination (XCITE/TERM supplied with controller). The maximum current that can be passed through the I/O module through the 24 Vdc and 0 V terminals from one module to the next is 2.5 A. Also see main controller for details of special cables.

**Environmental**

	:as for main controller except:
Safety USA/Canada	:UL rated as 'UL 916 listed accessory to open energy management equipment'. This document covers:
<b>Version</b>	
Firmware	v1.019
Boards	/8DO, /4DO: AM105145 Issue 2 /8UI, /4UI, /4UI/4AO, /2UI/2AO: AM105146 issue 1 /16DI, /8DI, /8DI/8TI: AM105825 issue 2 /8AO, /4AO: AM105873 issue 1 /HOA sub board AM105973 issue 2

Please send any comments about this or any other Trend technical publication to [techpubs@trendcontrols.com](mailto:techpubs@trendcontrols.com)

© 2009 Honeywell Technologies Sàrl, ECC Division. All rights reserved. Manufactured for and on behalf of the Environmental and Combustion Controls Division of Honeywell Technologies Sàrl, Z.A. La Pièce, 16, 1180 Rolle, Switzerland by its Authorized Representative, Trend Control Systems Limited.

Trend Control Systems Limited reserves the right to revise this publication from time to time and make changes to the content hereof without obligation to notify any person of such revisions or changes.

**Trend Control Systems Limited**

Albery House, Springfield Road, Horsham, West Sussex, RH12 2PQ, UK. Tel:+44 (0)1403 211888 Fax:+44 (0)1403 241608 [www.trendcontrols.com](http://www.trendcontrols.com)

**Trend Control Systems USA**

6670 185th Avenue NE, Redmond, Washington 98052, USA. Tel: (425)897-3900, Fax: (425)869-8445 [www.trendcontrols.com](http://www.trendcontrols.com)